User Manual

Lithium Battery Pack

Soluna 6K Pack HV (L-E)

Mar.2023 Revision A.1

About this manual

This manual describes how to install the Soluna 6K Pack HV (L-E) battery. Please read this manual carefully before you start to install the product, and follow the instructions throughout the installation process. If you are not sure about any of the requirements, recommendations, or safety procedures described in this manual, please contact Soluna immediately for advice and clarification. The information included in this manual is accurate at the time of publication. However, with regards to the product design and technical specification updates, our company reserves the right to make changes at any time without prior notice. In addition, the illustrations in this manual are meant to help explain system configuration concepts and installation instructions. The illustrated items maybe different from the actual items at the installation location.











Content

1 Safety precautions	4
1.1 Warning Sign	4
1.2 Safety instructions	4
1.2.1 Risks of explosion	5
1.2.2 Risks of fire	5
1.2.3 Risks of electric shock	5
1.2.4 Risks of damage to the battery pack	5
1.3 Battery handling guide	5
1.4 Response to emergency situations	6
1.4.1 Leaking batteries	6
1.4.2 Inhalation	6
1.4.3 Eye contact	6
1.4.4 Skin contact	6
1.4.5 Ingestion	6
1.4.6 Fire	6
1.4.7 Wet batteries	7
1.4.8 Damaged batteries	7
1.5 Qualified installers	7
2 Product Introduction	8
2.1 Features	8
2.2 Application	8
2.3 Outline Dimension	9
2.4 Technical data	10
2.5 Appearance	12
2.6 Connection port	13
2.7 CAN communication interface definition (CAN1 & CAN2)	14
3 Installation	15
3.1 Unpacking the package	15
3.2 Packing lists	16
3.3 Installation materials	16
3.4 Installation location	16
3.6 Installation requirement	18
3.7 Safety gear	19
3.8 Wiring specification	19
3.9 Wi-Fi module connection	20
4 Electrical connection	21
4.1 Single battery unit	21
4.2 The battery units are connected in parallel	21
5 How to operate Soluna 6K Pack HV (L-E)	23
6 LED indicator description	24
7 Trouble shooting guideline	25
8 DOD setting of Inverter	27
9 Contact us	27

1 Safety precautions

1.1 Warning Sign

Warning signs are used to warn you about the conditions that may cause severe injury or damage to the device. They instruct you to exercise caution to prevent danger. The following table describes the warning signs used in this manual.

Sign	Description
	This battery pack contains high voltage which can cause electric shock resulting in severe injury.
	Make sure that the battery polarity is connected correctly.
	Keep the battery pack away from open flame or ignition sources
	Keep the battery pack away from children.
	Read the manual before installing and operating the battery pack.
	The battery pack is heavy enough to cause severe injury
	The battery pack may leak corrosive electrolyte.
	The battery pack may explode.
	The battery pack should not be disposed with household waste at the end of its working life.
	Physical injury or damage to the devices may occur if related requirements are not followed.

1.2 Safety instructions

For safety reasons, installers are responsible for familiarizing themselves with the contents of this manual and all warnings before performing installation.

General safety precautions



Failure to observe the precautions described in this section can cause serious injury to persons or damage to property, observe the following precautions.

1.2.1 Risks of explosion

- Do not subject the battery pack to strong impacts.
- Do not crush or puncture the battery pack.
- Do not dispose of the battery pack in a fire.

1.2.2 Risks of fire

- Do not expose the battery pack to temperatures in excess of 60°C.
- Do not place the battery pack near a heat source, such as a fireplace.
- Do not expose the battery pack to direct sunlight.
- Do not allow the battery connectors to touch conductive objects such as wires.

1.2.3 Risks of electric shock

- Do not disassemble the battery pack.
- Do not touch the battery pack with wet hands.
- Do not expose the battery pack to moisture or liquids.
- Keep the battery pack away from children and animals.

1.2.4 Risks of damage to the battery pack

- Do not allow the battery pack to come in contact with liquids.
- Do not subject the battery pack to high pressures.
- Do not place any objects on top of the battery pack.

1.3 Battery handling guide

- Use the battery pack only as directed.
- Do not use the battery pack if it is defective, appears cracked, broken or otherwise damaged, or fails to operate.
- Do not attempt to open, disassemble, repair, tamper with, or modify the battery pack. The battery pack is not user serviceable.
- To protect the battery pack and its components from damage when transportation, handle with care.

-
- Do not impact, pull, drag or step on the battery pack.
 - Do not subject it to any strong force.
 - Do not insert foreign objects into any part of the battery pack.
 - Do not use cleaning solvents to clean the battery pack.

1.4 Response to emergency situations

The Soluna 6K Pack HV (L-E) battery pack comprises multiple batteries that are designed to prevent hazards resulting from failures. However, Soluna cannot guarantee their absolute safety.

1.4.1 Leaking batteries

If the battery pack leaks electrolyte, avoid contact with the leaking liquid or gas. The electrolyte is corrosive and contact may cause skin irritation and chemical burns. If someone is exposed to the leaked substance, do these actions:

1.4.2 Inhalation

Evacuate the contaminated area, and seek medical attention immediately.

1.4.3 Eye contact

Rinse eyes with flowing water for 15 minutes, and seek medical attention immediately.

1.4.4 Skin contact

Wash the affected area thoroughly with soap and water, and seek medical attention immediately.

1.4.5 Ingestion

Induce vomiting, and seek medical attention immediately.

1.4.6 Fire

In case there is a fire, always have an ABC or carbon dioxide extinguisher.



The battery pack may catch fire when heated above 150°C.

If a fire breaks out where the battery pack is installed, do these actions:

- Extinguish the fire before the battery pack catches fire.
- If it is impossible to extinguish the fire but you have time, move the battery pack to a safe area before it catches fire.
- If the battery pack has caught fire, do not try to extinguish it. Evacuate people immediately.



If the battery catches fire, it will produce noxious and poisonous gases. Do not approach.

1.4.7 Wet batteries

If the battery pack is wet or submerged in water, do not try to access it. Contact Soluna or your distributor for technical assistance.

1.4.8 Damaged batteries

Damaged batteries are dangerous and must be handled with extreme caution. They are not fit for use and may pose a danger to people or property.

If the battery pack seems to be damaged, pack it in its original container, and then return it to Soluna or your distributor.



Damaged batteries may leak electrolyte or produce flammable gas. If you suspect such damage, immediately contact Soluna for advice and information.

1.5 Qualified installers

This manual and the tasks and procedures described herein are intended for use by skilled workers only. A skilled worker is defined as a trained and qualified electrician or installer who has all of the following skills and experience:

- Knowledge of the functional principles and operation of on-grid systems.
- Knowledge of the dangers and risks associated with installing and using electrical devices and acceptable mitigation methods.
- Knowledge of the installation of electrical devices.
- Knowledge of and adherence to this manual and all safety precautions and best practices.

2 Product Introduction

Soluna 6K Pack HV (L-E) is a LFP lithium battery product with BMS (battery management system). It is a high-voltage battery module with CAN communication, under-voltage, over-voltage, over-current, over-temperature, under-temperature protection functions. It has the characteristics of high energy density, long life, safety and reliability and so on, and It is your trustworthy green environmental product.

2.1 Features

- Excellent safety performance
- Long cycle life
- Support for CAN-communication
- High energy density
- Excellent battery management system
- Number of expandable battery units
- Wi-Fi monitor

2.2 Application

- Back-up power
- Micro-grid
- Home Energy Storage system

2.3 Outline Dimension

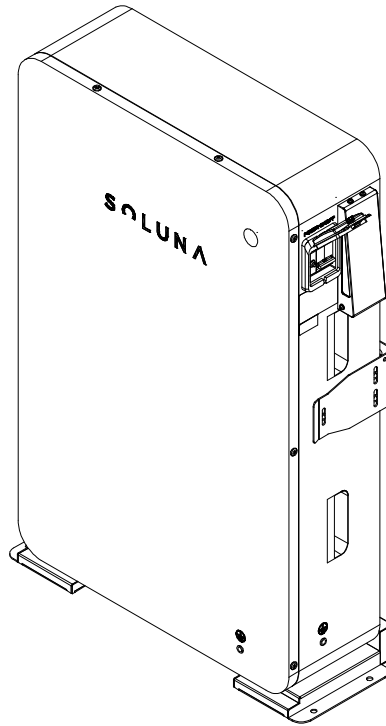

Width	654	mm
Depth	227	mm
Height	971	mm
Weight	74	kg

2.4 Technical data

Physical Characteristics

Width	654mm
Depth	227mm
Height	971mm
Weight	74kg

Electrical Characteristics

Battery type	LFP
Total Energy Capacity	6kWh
Usable Energy Capacity	5.4kWh
Battery Capacity (Nominal)	40Ah
Voltage Range (Usable)	134.4~168V
Nominal Voltage	153.6V
Charge voltage (CV)	168V
Discharge cut-off voltage	134.4V
Charge/Discharge Current (Nominal)	20A/20A
Charge/Discharge Current (Max)	40A/40A
DOD	90%
Cycle life @ 25°C (under standard charge and discharge conditions, charge 0.2C, discharge 0.2C)	≥6000
DC Disconnect	Contact Fuse
Number of expandable battery units	10

BMS

Power consumption	≤100mA (work), ≤0.1mA (sleep)
Monitoring parameters	System Voltage System Current Cell Voltage Cell temperature
Communication	CAN

Operating Conditions

Condition	Indoor conditioned
Operating Temperature	-10~50 °C
Operating Temperature (Recommended)	15~30 °C
Storage Temperature	-30~60 °C

Humidity	5%~95%
Altitude	Max. 2,000 m
Cooling Strategy	Natural Convection

Reliability & Certification

Certificates	Cell: UL1642 Battery Module: IEC62619 UL1973,UL9540A
Transportation	UN38.3
Ingress Rating	IP54

Warranty

Please refer to SOLUNA WARRANTY CONDITIONS
--

2.5 Appearance

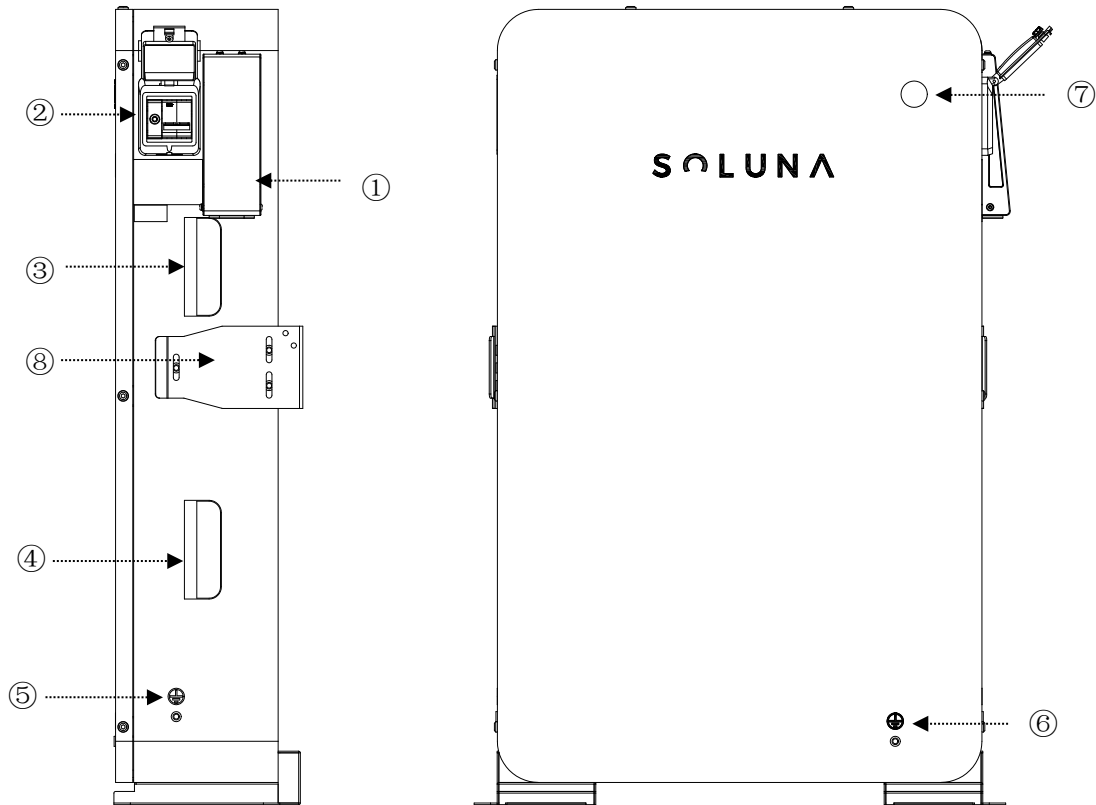

Number	Name	Remark
①	Cable connection interface	
②	Power ON/OFF switch	
③④	Handle	
⑤⑥	Grounding points	
⑦	Status indicator light	
⑧	Bracket attached to wall	

2.6 Connection port

User can see the connections port of Soluna 6K Pack HV (L-E) after the cover cap opened, please see the below picture in details.

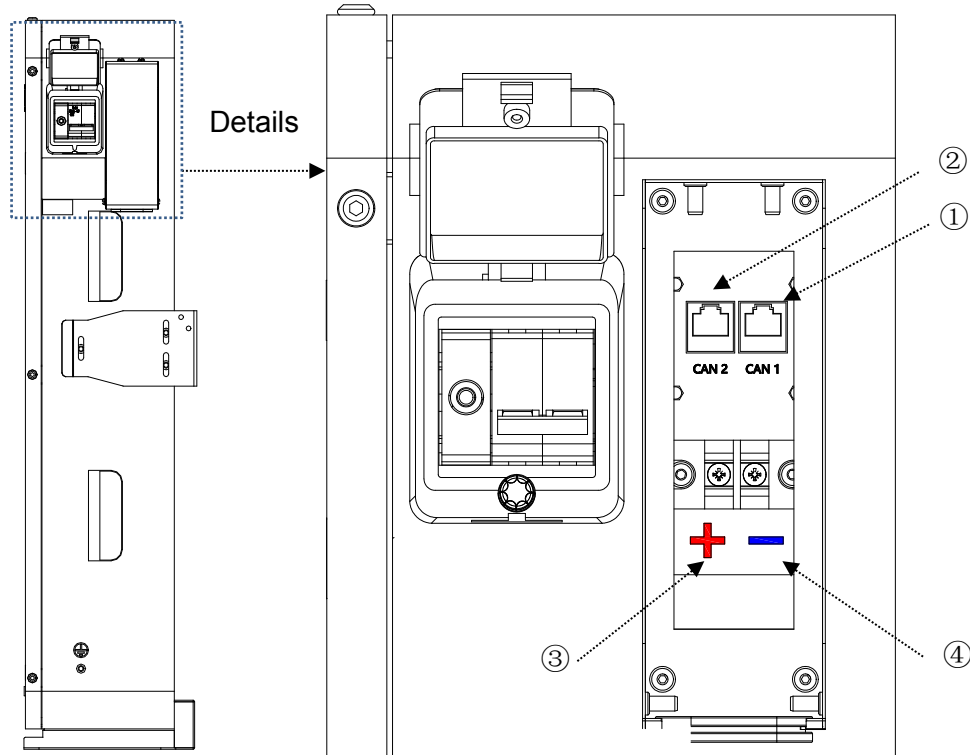

Number	Name	Remark
①	CAN1 port	For external communication (inverter)
②	CAN2 port	For internal communication (BMS)
③	Battery+	
④	Battery-	

2.7 CAN communication interface definition (CAN1 & CAN2)

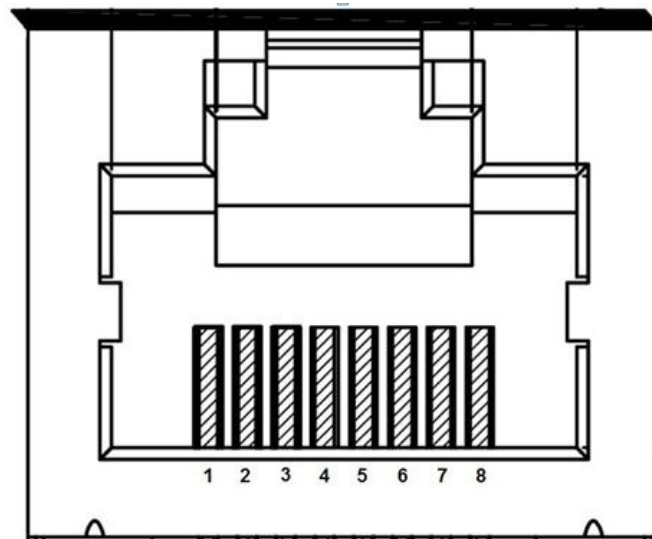

2.7.1 CAN1 port (for inverter communication)

1	2	3	4	5	6	7	8
—	—	—	CAN1H	CAN1L		—	—

2.7.1 CAN2 port (for battery communication)

1	2	3	4	5	6	7	8
485A	485B	GND	CAN1H	CAN1L	+12V	CAN2H	CAN2L

3 Installation

	The battery pack is too heavy for one to carry. Make sure that two or more persons are moving the battery pack together.
---	--

3.1 Unpacking the package

3.1.1 Please see the packaging of Soluna 6K Pack HV(L-E) below.

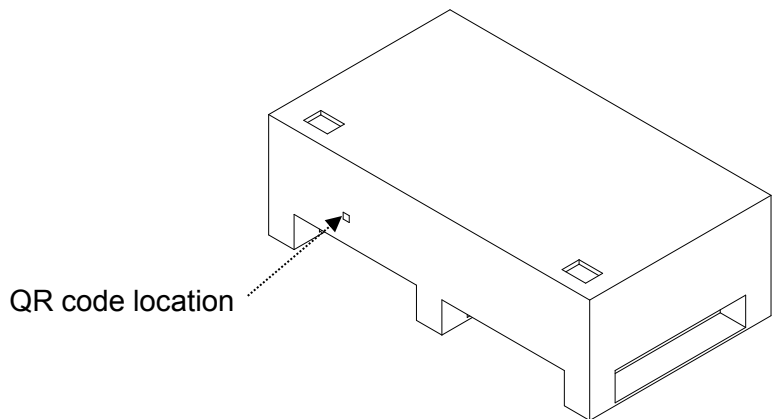

Remark: Users can scan the QR code on the package to obtain the electronic user Manual.

3.1.2 Open the packing box, take out the wall bracket and remove the EPE plate.

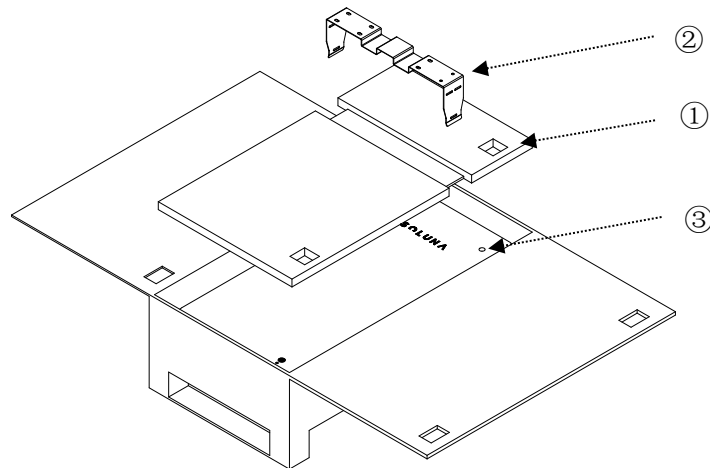

Number	Name	Remark
①	EPE plate	
②	Wall bracket	
③	Soluna 6K Pack HV (L-E)	

-
- 3.1.3 Pull out the battery pack and stand it upright. Check if the battery pack is damaged.
 - 3.1.4 All the other items are contained in a box in one corner of the carton. Take them out and check if any item is missing
 - 3.1.5 Keep the carton for future storage or transportation

3.2 Packing lists

The following table lists the numbers of each item included. If anything is damaged or missing, contact Soluna or your distributor.

Item	Name	Qty (pcs)	Remark
1	Soluna 6K Pack HV (L-E)	1	
2	PE wire	1	
3	Allen wrench (M2.0)	1	
4	M4 Phillips screw	4	
5	M6 Phillips screw	10	
6	M8 expansion screw	8	
7	Wall bracket	1	
8	CAN communication wire	1	

3.3 Installation materials

These installation materials shall be prepared by installers.

- Charging cables
- Network cables
- DC breaker

3.4 Installation location

Please make sure that the installation location meets the following conditions:

- The building is designed to withstand earthquakes.
- The location is far away from the sea, to avoid salt water and humidity.
- The floor is flat and level.
- There are no flammable or explosive materials nearby.
- The ambient temperature is between 15 and 30°C.
- The temperature and humidity stays at a constant level.
- There is minimal dust and dirt in the area.
- There are no corrosive gases present, including ammonia and acid vapor.



If the ambient temperature is outside the operating range, the battery pack stops operating to protect itself. The optimal temperature range for the battery pack to operate is 15°C to 30°C. Frequent exposure to harsh temperatures may deteriorate the performance and lifetime of the battery pack.

3.5 Installation tools

The following tools are required to install the battery pack.

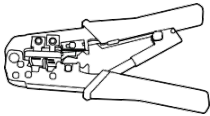
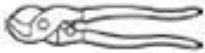
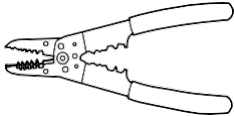
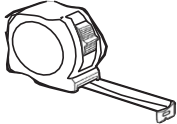
Item	Photo	Name
1		Phillips-screwdriver bit
2		Network crimper
3		Wire cutters
4		Wire stripper
5		Tape measure

Use properly insulated tools to prevent accidental electric shock or short circuits. Use adjustable tools and measuring instruments that are certified for precision and accuracy.

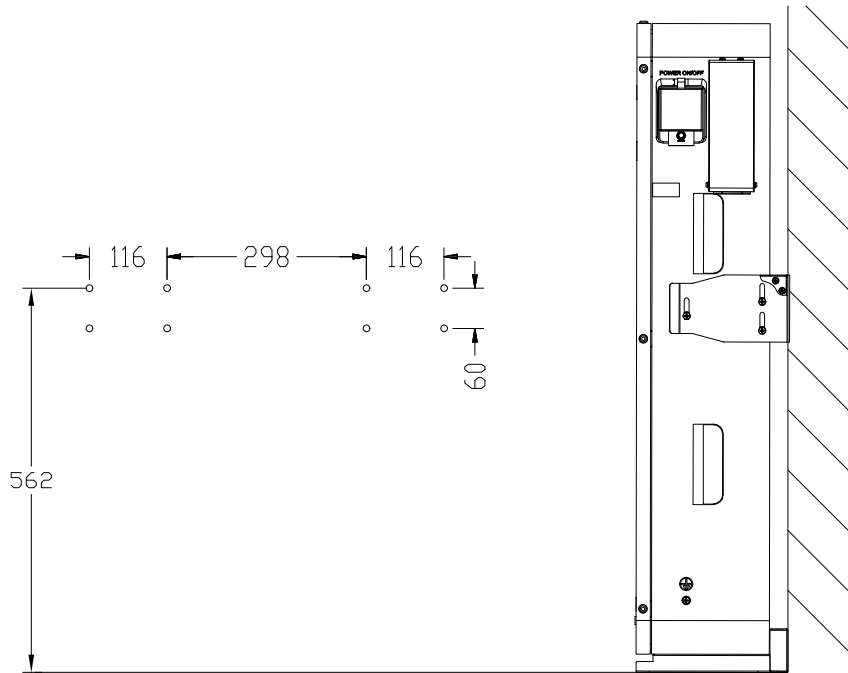

3.6 Installation requirement

Soluna 6K Pack HV (L-E) should be installed attached the wall, Eight holes should be drilled on the wall in order to fix the racks of the battery module. Please find the following pictures for details.



3.7 Safety gear

Wear the following safety gear when dealing with the battery pack. Installers must meet the relevant requirements of international standards, such as IEC 60364, or the domestic legislation.

Item	Photo	Name
1		Insulated gloves
2		Safety goggles
3		Safety shoes

3.8 Wiring specification

In order to standardize the wiring specification of Soluna 6K Pack HV (L-E), the following requirements are required for connecting wires of Soluna 6K Pack HV (L-E).

Battery cable	Communication cable
It is recommended to use 8AWG of conductor with double insulation	It is recommended to use Standard communication cable with shielding function

3.9 Wi-Fi module connection

3.9.1 Single battery unit

Wi-Fi module should be connected to the CAN2 port of battery with Wi-Fi cable,
Please find the following position of Wi-Fi module for details.

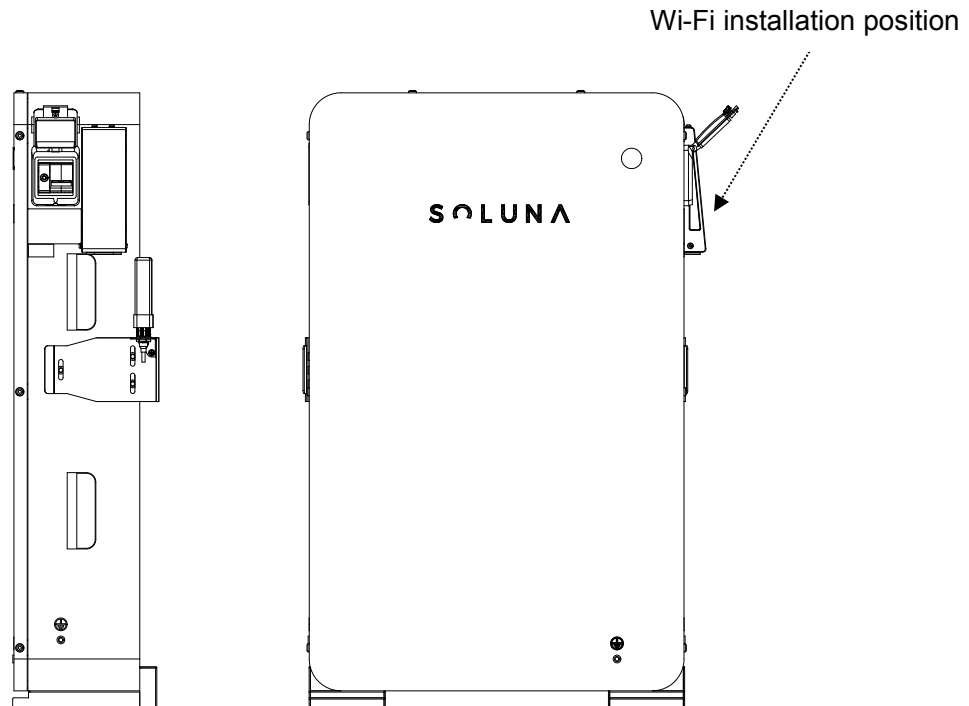

3.9.2 The battery units are connected in parallel

User only need to install 1 unit Wi-Fi module on the HV parallel box, Please
find the following position of Wi-Fi module for details.

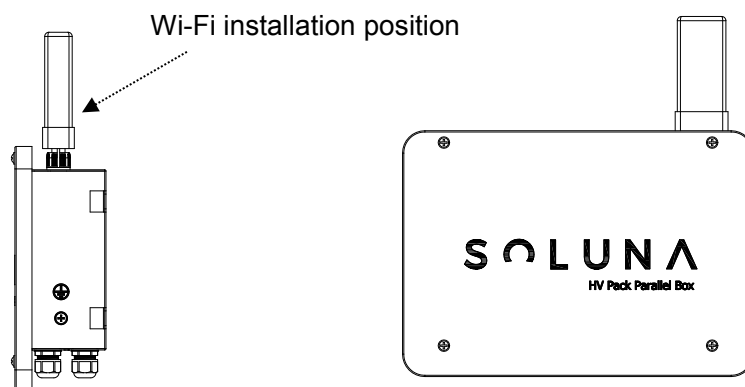

Remark:

- 1) User can find the user manual of Wi-Fi module in the Wi-Fi packing box

4 Electrical connection

4.1 Single battery unit

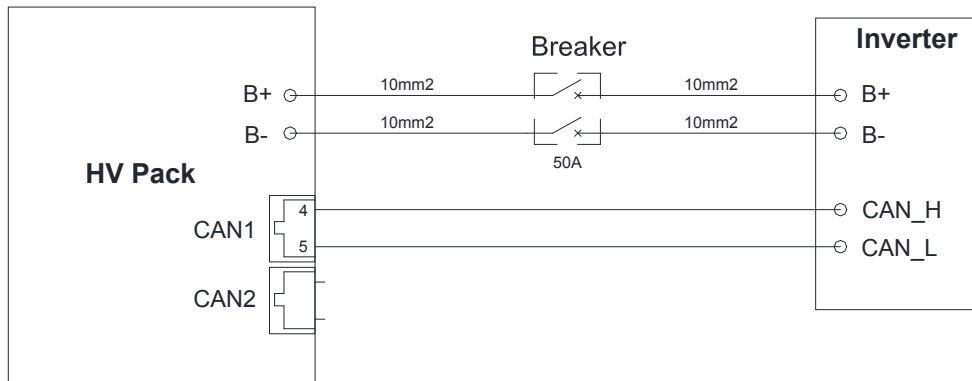

4.2 The battery units are connected in parallel

a) 2~4 units in parallel connection

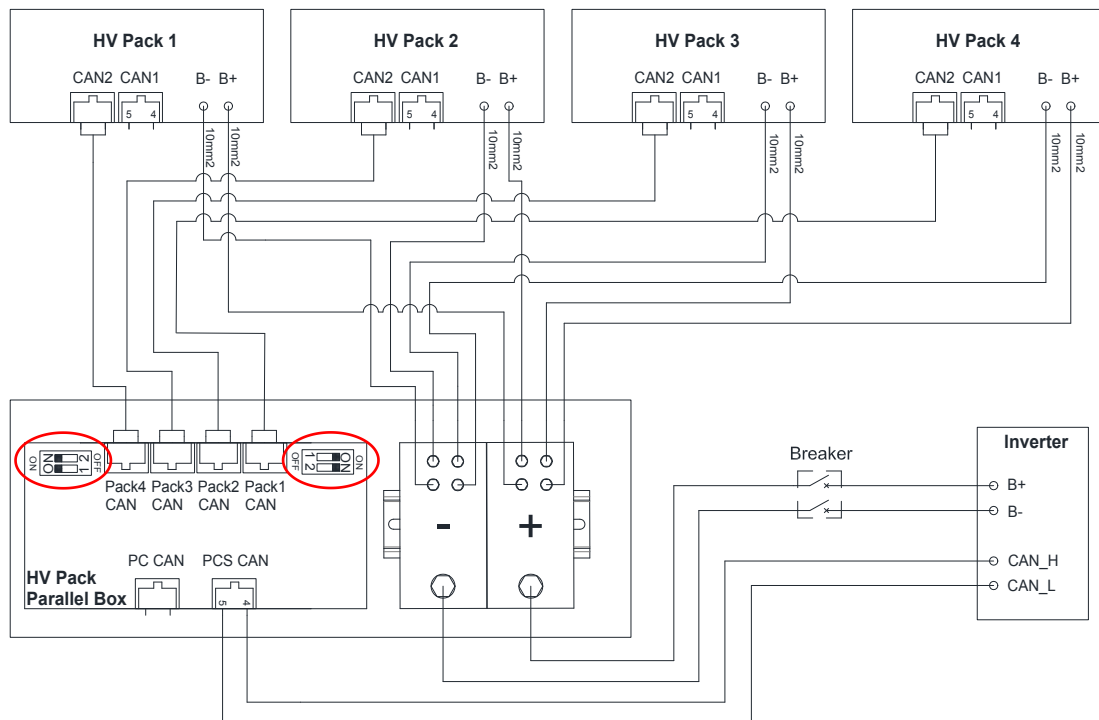

Remark:

The “1&2” on the dial resistance of the HV Pack Parallel Box should be turned to the “ON” position, please find the above drawing in red cycle

B) 5~7units in parallel connection

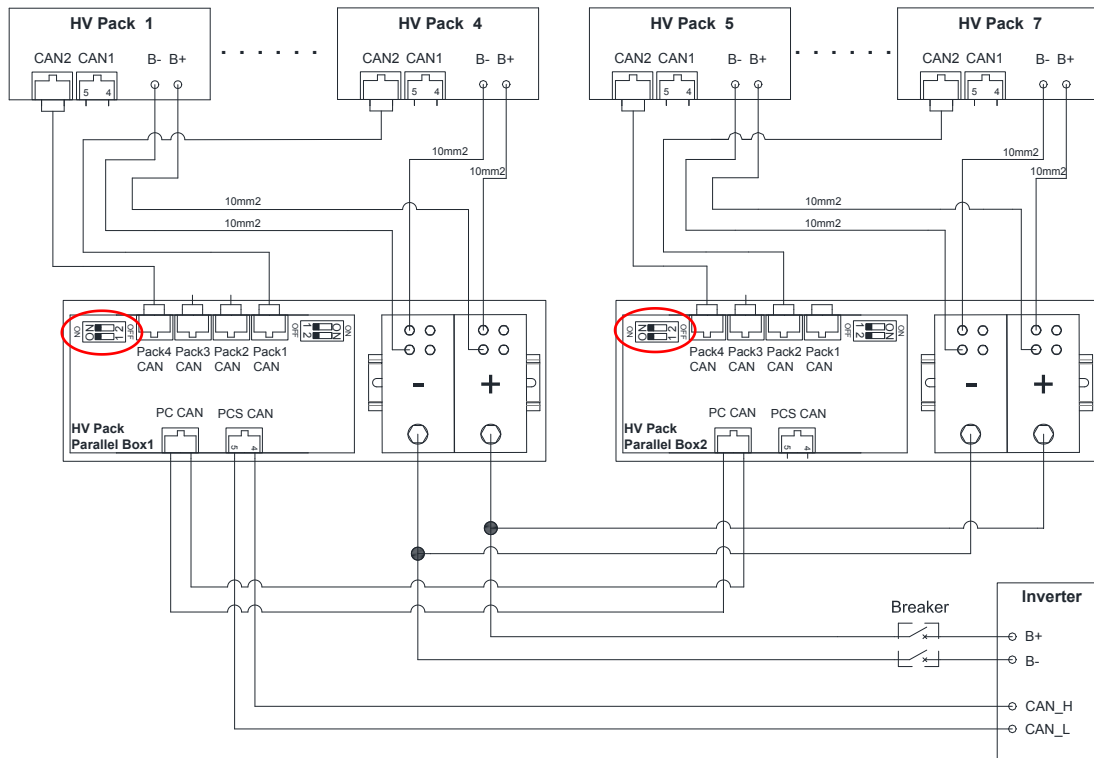

Remark:

The “1&2” on the dial resistance of the HV Pack Parallel Box should be turned to the “ON” position, please find the above drawing in red cycle.

C) 7~10units in parallel connection

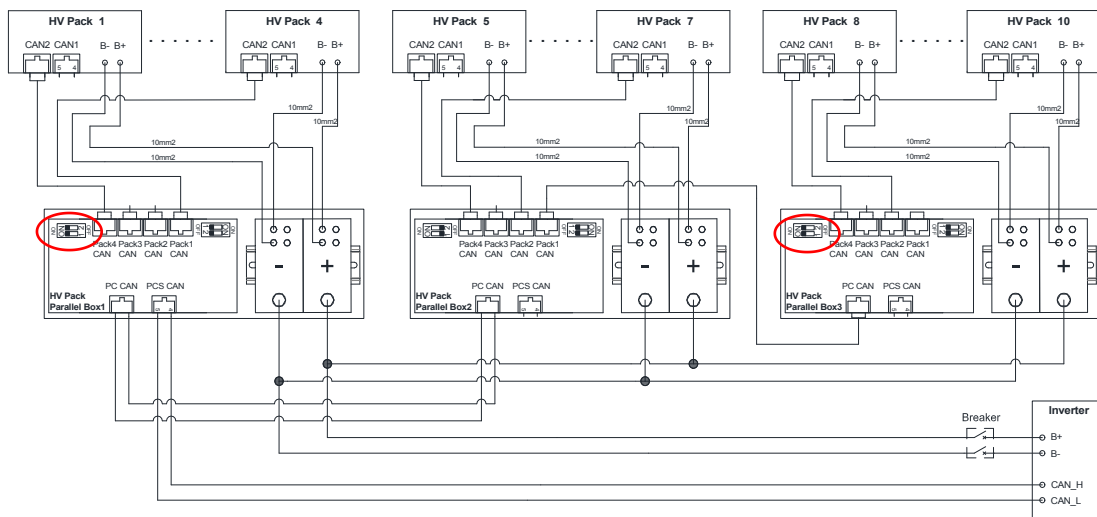

Remark:

The “1&2” on the dial resistance of the HV Pack Parallel Box should be turned to the “ON” position, please find the above drawing in red cycle.

5 How to operate Soluna 6K Pack HV (L-E)

Step: please see below information for details.

- 1) Connect the inverter and battery module with communication & battery cable
- 2) Turn on the breaker , the breaker is on the right side of Soluna 6K Pack HV (L-E).

Please see below figure for details.

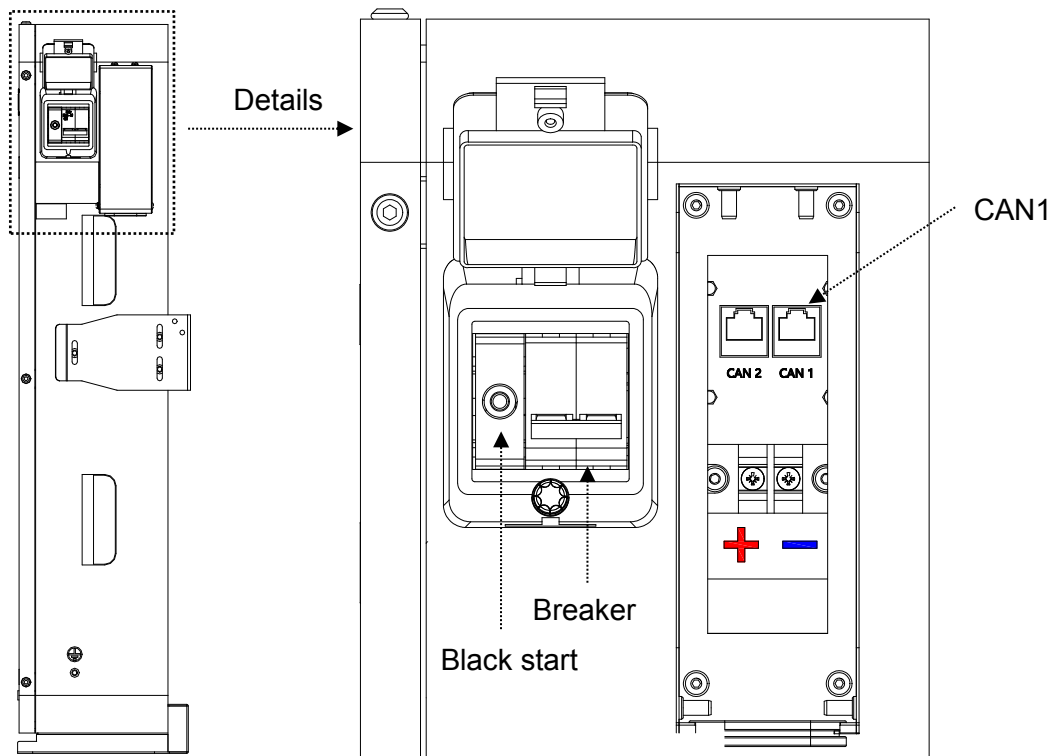

Remark:

- 1) CAN1 is connected to inverter for communication.
- 2) Soluna 6K Pack HV (L-E) can only operate after receiving the inverter's communication instructions.
- 3) After the system is powered on, the user needs to select the battery communication protocol on the inverter, so that the system can run normally.
- 4) In pure off-grid case when the first installation is completed, if there is no PV power, long press the battery black start switch to start the system.

6 LED indicator description

Please find the following table for details.

Item	Color	Description
1	Red	Battery is on black start mode. To active battery black start mode, please press the black start button and hold for 10 seconds. Battery can power the inverter and active the communication with inverter if there is no power grid or solar panels.
2	Purple	Battery has lost communication with inverter for over 5 minutes.
3	Yellow	Battery is on protection model. The battery reached to the 3 rd level protection alarm such as over voltage, under voltage, over temperature, low temperature, etc.
4	White	Battery is on working model. If there are more than one battery in parallel connection, it means this battery is the master battery on working model.
5	Green	Battery is on working model as a slave battery in parallel connection.

7 Trouble shooting guideline

Please find the following table for details.

Led Indicator	Possible root cause	How to target the root cause	Solution
Led is purple	1) Compatible inverter firmware is not the latest reversion.	Please check the inverter APP or LCD/LED for firmware reversion.	Update inverter's firmware.
	2) Battery firmware is not the latest reversion.	Please check the Soluna smart energy cloud for firmware reversion.	Update battery's firmware.
	3) Installer didn't choose Soluna battery correctly on inverter APP or LCD/LED.	Please check if the selection of battery is correct or not.	Reselect Soluna battery on inverter.
	4) Communication cable is loose or not correct.	Please check the communication cable status.	Replug or change the communication cable.
	5) Inverter hardware fault.	Please change another inverter to try.	Contact with inverter manufacture.
	6) Battery hardware fault.	If you checked all the items above and still can't target the reason, please contact with Soluna. Or change the battery.	Contact with Soluna for further action.
N/A (Battery can't be charged or discharged)	1) Inverter setting incorrect such as disable the charging or discharging, and time setting, etc.	Check the inverter setting.	Change the inverter setting.
	2) Inverter can't read Soluna battery type correctly.	Please check the battery type of product and product name shown in inverter side.	Contact with Inverter manufacture or Soluna for further action.
	3) Inverter hardware fault.	Please change another inverter to try.	Contact with Inverter manufacture.
	4) Battery hardware fault.	Please change another battery to try.	Contact with Soluna for further action.
Led is off or yellow	1) Off-grid installation, battery can't be charged for over 2 weeks due to no production of PV system(raining season, snow season, or PV system fault).	Check the battery voltage through the reserved service port. If the 15K HV voltage is less than 300V, 10K HV voltage is less than 210V, 6K HV voltage is less than 120V, please turn off the battery and contact with Soluna.	Contact with Soluna for further action.

	<p>2) Customer didn't turn off the battery for over 2 weeks in the scenario such as:</p> <p>A. Installation is not finished.</p> <p>B. System failure, not running.</p>	<p>Check the battery voltage through the reserved service port. If the 15K HV voltage is less than 300V, 10K HV voltage is less than 210V, 6K HV voltage is less than 120V, please turn off the battery and contact with Soluna.</p>	<p>Contact with Soluna for further action.</p>
	<p>3) The battery was stocked for over 2 years without charging.</p>	<p>Check the battery voltage through the reserved service port. If the 15K HV voltage is less than 300V, 10K HV voltage is less than 210V, 6K HV voltage is less than 120V, please turn off the battery and contact with Soluna.</p>	<p>Contact with Soluna for further action.</p>
N/A	<p>1) Battery firmware is not updated to latest.</p>	<p>Please check the Soluna smart energy cloud for battery firmware reversion.</p>	<p>Updating the battery firmware to the latest.</p>
<p>Master battery is white, but not all slaver battery are green</p>	<p>1) Battery communication cable is loose or not correct.</p>	<p>Check the communication cable status.</p>	<p>Replug or change the communication cable.</p>
	<p>2) Battery power cable is loose, or not correct connected.</p>	<p>Check the battery power cable.</p>	<p>Fasten the power cable.</p>
	<p>3) Communication terminal resistor is not dailed or not dailed correctly.</p>	<p>Check the parallel box for the resistor dailling.</p>	<p>Dail the terminal resistor according to manual or SOP.</p>
	<p>4) Battery firmware is not the latest.</p>	<p>Please check the Soluna smart energy cloud for battery firmware reversion.</p>	<p>Upgrade the firmware to the latest.</p>
N/A	<p>1) The Wifi network is not compatible</p>	<p>Check the ender user network type.</p>	<p>Please choose only 2.4G wifi mode.</p>
	<p>2) Connecting fail</p>	<p>APP will remind.</p>	<p>Please read the SOP of wifi setting up.</p>
	<p>3) System establish failed due to S/N invalid.</p>	<p>APP will remind.</p>	<p>Contact with Soluna for further action.</p>
N/A	<p>1) Battery reach to 1st level alarm such as battery over voltage.</p>	<p>Please check the Soluna smart energy cloud for battery alarm information.</p>	<p>Please ignore it, this alarm message is only used for inverter strategy. The power of charging/ discharging will be reduced.</p>

	2) Battery reach to 2nd level alarm such as battery over voltage.	Please check the Soluna smart energy cloud for battery alarm information.	Please ignore it, this alarm message is only used for inverter strategy. The power of charging/ Discharging will be limited.
Yellow	1) Battery reach to 3rd level alarm such as battery over voltage.	1) Please check the inverter LCD/LED or APP for the battery alarm information. 2) Please check the Soluna smart energy cloud for battery alarm information.	Battery will shut down, please contact with Soluna for further action.

8 DOD setting of Inverter

To make sure the battery working smoothly, we recommend the DOD setting of inverter as follows.

On-grid DOD: 80%

Off-grid DOD: 70%

9 Contact us

We hope that this user manual has clearly demonstrated the product. If you still have any doubts or something not clear about it in the specifications, feel free contact to us please. we will do our best to support you!

SOLUNA

Add: No.3492 Jinqian Road, Shanghai, China 201406

Tel: +86-21-57475835

Email: sales@solunabattery.com

Web: www.solunabattery.com