

User Manual
Battery Energy Storage System
Soluna 10K Pack LV
A.3

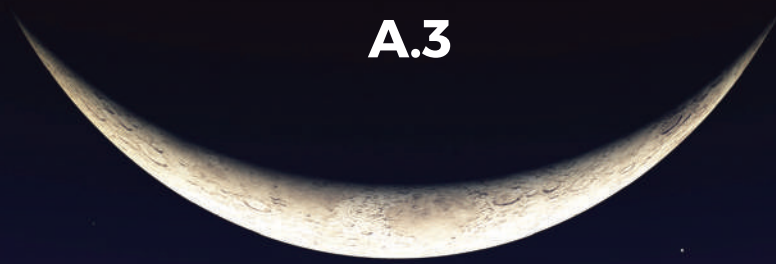

About this Specification

This manual provides comprehensive instructions for installing the Soluna 10K Pack LV. It is imperative to thoroughly read this manual before attempting to install the product and to follow the instructions diligently throughout the installation process.

If you have any doubts about the requirements, recommendations, or safety procedures described in this manual, please contact Soluna immediately for advice and clarification.

The information contained in this manual is accurate at the time of publication. However, due to ongoing updates to product design and technical specifications, our company reserves the right to make changes at any time without prior notice. Additionally, the illustrations included in this manual are intended to aid in explaining system configuration concepts and installation instructions. The items depicted in the illustrations may differ from the actual items at the installation site.

SOLUNA (SHANGHAI) CO.,LTD reserves the copyright of this document.

1. Introduction.....	05
2. Features.....	06
2.1 Features.....	06
2.2 Application.....	06
3. Safety Precautions.....	07
3.1 Warning Sign.....	07
3.2 Safety Instructions.....	08
3.2.1 Risks of Explosion.....	08
3.2.2 Risks of fire.....	08
3.2.3 Risks of electric shock.....	08
3.2.4 Risks of damage to the battery pack.....	08
3.3 Battery handling guide.....	09
3.4 Response to emergency situations.....	09
3.4.1 Leaking batteries.....	09
3.4.2 Inhalation.....	09
3.4.3 Eye contact.....	09
3.4.4 Skin contact.....	09
3.4.5 Ingestion.....	10
3.4.6 Fire.....	10
3.4.7 Wet batteries.....	10
3.4.8 Damaged batteries.....	11
3.5 Qualified installers.....	11
4. Appearance.....	12
5. Technical parameters.....	14
6. Connection Port.....	17
7 COM Communication Interface Definition.....	19
8 LED Lights Definition.....	20
9 Installation.....	21
9.1 Packing Lists.....	21
9.2 Installation Materials.....	22
9.3 Installation Location.....	22
9.4 Installation Tools Requirements.....	23
9.5 Wiring Specification.....	24

9.6 Installation Method.....	25
9.7 Installation Method.....	26
9.8 CAN communication connection.....	27
10. Electrical connection.....	28
11. How to operate Soluna 10K Pack LV	30
12. Trouble shooting guideline.....	31
13. Depth of Discharge (DOD) Setting for inverter.....	34
14. Register on the Website after Installation	35
15. Contact us	36

1 Introduction

The Soluna 10K Pack LV is an advanced LFP lithium battery product designed to meet the highest standards of performance and safety. Equipped with a sophisticated Battery Management System (BMS), this low-voltage battery module features CAN/RS485 communication for seamless integration and monitoring. It includes comprehensive protections against under-voltage, over-voltage, over-current, over-temperature, and under-temperature, ensuring optimal performance and safety under various conditions.

With its high energy density, long lifespan, and robust reliability, the Soluna 10K Pack LV stands out as a green environmental product you can trust. Its innovative design not only enhances efficiency but also contributes to sustainability, making it an ideal choice for Backup Power, Micro-grid Solutions, and Small Industrial & Commercial Energy Storage Systems.

2.1 Features

- **Excellent Safety Performance**
Ensures the highest level of safety under various conditions.
- **Long Cycle Life**
Designed for extended usage without significant performance degradation.
- **Support CAN/RS485**
Allows seamless integration and communication with other systems.
- **Parallel Interconnection**
Enables the connection of several systems in parallel for increased capacity.
- **Expandable Battery Units**
Provides flexibility to scale the system as needed.
- **Backup Power**
Reliable power supply during outages.
- **Micro-grid**
Supports independent and sustainable energy systems.
- **Home Energy Storage System**
Efficiently stores energy for residential use.













2.2 Application

- Back-up power
- Micro-grid
- Home Energy Storage system

3 Safety Precautions

3.1 Warning Signs

Warning signs are essential indicators designed to alert you to conditions that could result in severe injury or significant damage to the device. They serve as critical reminders to exercise caution and take necessary precautions to prevent hazardous situations. The table below outlines the warning signs used in this manual and their meanings:

Sign	Description
	High Voltage Warning: This battery pack operates at high voltage, which can cause severe injury due to electric shock.
	Correct Polarity: Ensure the battery polarity is correctly connected.
	Fire Safety: Keep the battery pack away from open flames or ignition sources.
	Child Safety: Store the battery pack out of reach of children.
	Installation Manual: Thoroughly read the manual before installing and operating the battery pack.
	Heavy Weight Warning: The battery pack is heavy, and improper handling may result in severe injury. Utilize proper lifting techniques.
	Electrolyte Leakage: The battery pack may leak corrosive electrolyte. Handle with care and adhere to appropriate safety procedures.
	Explosion Risk: The battery pack may explode under certain conditions.
	Disposal Instructions: Do not dispose of the battery pack with household waste at the end of its working life. Follow local regulations for disposal.
	Compliance Requirement: Failure to follow the provided requirements and guidelines may lead to physical injury or damage to the device.
	Do not short circuit.
	Grounding conductor This symbol indicates the position for connecting a grounding conductor.

3.2 Safety Instructions

For safety reasons, it is crucial that installers thoroughly familiarize themselves with the contents of this manual and all associated warnings prior to commencing the installation.



General Safety Precautions

Failure to adhere to the precautions outlined in this section can result in serious injury or property damage. Please observe the following safety guidelines:

3.2.1 Risks of Explosion

- Avoid subjecting the battery pack to strong impacts.
- Do not crush or puncture the battery pack.
- Never dispose of the battery pack in a fire.

3.2.2 Risks of Fire

- Do not expose the battery pack to temperatures exceeding 60°C.
- Keep the battery pack away from heat sources, such as fireplaces.
- Avoid exposing the battery pack to direct sunlight.
- Ensure the battery connectors do not come into contact with conductive objects like wires.

3.2.3 Risks of Electric Shock

- Refrain from disassembling the battery pack.
- Do not touch the battery pack with wet hands.
- Keep the battery pack away from moisture or liquids.
- Ensure the battery pack is kept away from children and animals.

3.2.4 Risks of Damage to the Battery Pack

- Prevent the battery pack from coming into contact with any liquids.

3.3 Battery Handling Guide

- Use the battery pack strictly as directed in the manual.
- Do not use the battery pack if it appears defective, cracked, broken, or fails to operate correctly.
- Do not attempt to open, disassemble, repair, tamper with, or modify the battery pack as it is not user serviceable.
- Handle the battery pack with care during transportation to avoid damage.
- Avoid impacting, pulling, dragging, or stepping on the battery pack.

3.4 Response to Emergency Situations

The Soluna 10K Pa ck LV consists of multiple batteries designed to prevent hazards resulting from failures. However, Soluna cannot guarantee absolute safety. Please familiarize yourself with the following emergency procedure.

3.4.1 Leaking Batteries

If the battery pack leaks electrolyte, avoid contact with the leaking liquid or gas. Electrolyte is corrosive and contact may cause skin irritation and chemical burns. If exposed to the leaked substance, follow these steps:

3.4.2 Inhalation

- Evacuate the contaminated area immediately.
- Seek medical attention without delay.

3.4.3 Eye Contact

- Rinse eyes with flowing water for at least 15 minutes.
- Seek medical attention immediately.

3.4.4 Skin Contact

- Wash the affected area thoroughly with soap and water.
- Seek medical attention immediately.

3.4.5 Ingestion

- Induce vomiting.
- Seek medical attention immediately.

3.4.6 Fire Response Procedures

In the event of a fire, always have an ABC or carbon dioxide extinguisher on hand.



The battery pack may ignite if heated above 150 °C. If a fire occurs where the battery pack is installed, follow these steps:

- **Extinguish Early**

Attempt to extinguish the fire before the battery pack ignites.

- **Safe Relocation**

If extinguishing is not possible but time allows, move the battery pack to a safe area before it catches fire.

- **Evacuate**

If the battery pack has already caught fire, do not attempt to extinguish it. Evacuate the area immediately.



Caution: If the battery catches fire, it will emit noxious and poisonous gases. Do not approach the fire.

3.4.7 Wet Batteries

If the battery pack becomes wet or submerged in water, do not attempt to access it. Contact Soluna or your distributor for technical assistance immediately.

3.4.8 Damaged Batteries

Damaged batteries are hazardous and must be handled with extreme caution. They are unfit for use and may pose a danger to people or property.

If the battery pack appears damaged, pack it in its original container and return it to Soluna or your distributor.



Leakage and Flammability: Damaged batteries may leak electrolyte or produce flammable gas. If you suspect such damage, contact Soluna for advice and information immediately.

3.5 Qualified Installers

This manual, along with the tasks and procedures described herein, is intended for use by skilled professionals only. A skilled professional is defined as a trained and qualified electrician or installer who possesses all of the following skills and experience:

- **Functional Knowledge**

Understanding of the principles and operation of on-grid systems.

- **Risk Awareness**

Awareness of the dangers and risks associated with installing and using electrical devices and the acceptable methods for mitigating these risks.

- **Installation Proficiency**

Expertise in the installation of electrical devices.

- **Adherence to Guidelines**

Knowledge of and compliance with this manual, including all safety precautions and best practices.

- **Battery Maintenance**

Only authorized personnel should perform maintenance. Turn off the battery before maintenance. Periodically check voltage, SOC, and cables for damage or wear. Perform balancing maintenance (fully charge) every three months.

- **Installation Environment Requirements**

Avoid flammable, explosive, or corrosive materials. Keep out of children's reach and avoid high temperatures. Ensure proper ventilation and avoid electromagnetic interference. Install in a sheltered, well-ventilated area, within the appropriate temperature and humidity range, and below 2000 meters altitude.

4 Appearance

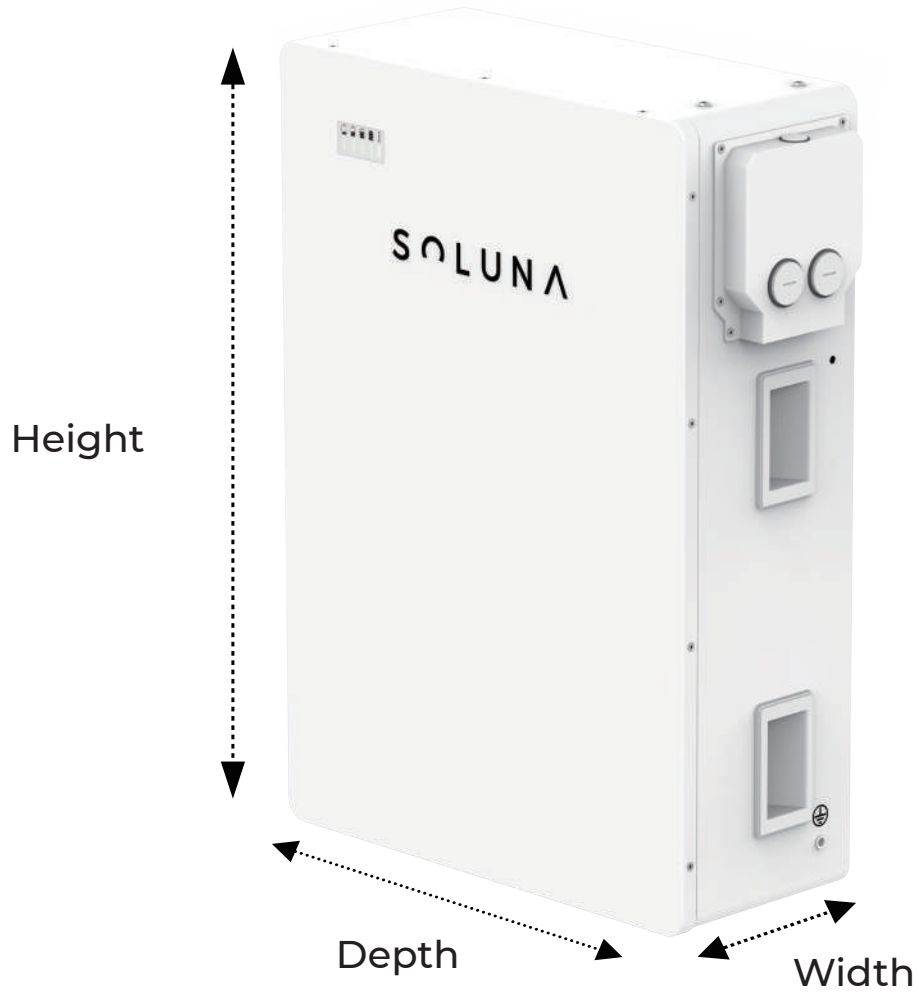

Width	215	mm
Depth	500	mm
Height	730	mm
Weight	94	kg

4 Appearance



Number	Name	Description
1	Logo	Soluna brand
2	Cable connection interface	A port or set of ports designed for connecting cables, such as USB, HDMI, or Ethernet, to establish connections with other devices or networks.
3	Power ON/OFF switch	A physical toggle or push-button control to turn the device on or off. It may include additional features, like an LED indicator to show the device's power status.
4	Battery capacity & Status indicator light	A display or light system that shows the battery's capacity (measured in milliam p-hours, mAh, or watt-hours, Wh) and status (e.g., charging, full, or low battery), often using colors or blinking patterns.
5	Handle	A functional component made of durable material, designed for portability and ease of carrying. It may feature ergonomic grips for added comfort.

5 Technical parameters

Physical Characteristics	
Width	215 mm
Depth	500 mm
Height	730 mm
Weight	94 kg
Electrical Characteristics	
Battery type	LFP
Total Energy Capacity	10.24kWh
Usable Energy Capacity	9.20kWh
Battery Capacity (Nominal)	200Ah
Nominal Voltage	51.2V
Usable Voltage Range	48~57.3V
Charge Current (Recommended)	100A
Discharge Current (Recommended)	100A
Max. Continuous Charge Current	100A
Max. Continuous Discharge Current	200A
Recommended Depth of Discharge	80% ^①
Max. Depth of Discharge	90%
Internal resistance	≤20mΩ
Cycle life @ 25°C(under standard charge and discharge Conditions)	≥8000 ^②
DC Disconnect	Contactora / Fuse
Warranty	

5 Technical parameters

Please refer to Soluna WARRANTY CONDITIONS	
BMS	
Power consumption	<3W (work), <100mW (sleep)
Monitoring parameters	System Voltage System Current Cell Voltage Cell Temperature
Communication	CAN / RS485
Protection	Over Voltage, Under Voltage Over Current, Over Temperature Under Temperature
System Configuration	
Module parallel	1~30 Parallel
Operating Conditions	
Installation Location	Indoor / Outdoor
Operating Temperature	-10~50 °C
Operating Temperature (Recommended)	15~ 30°C ③
Storage Temperature	15~5 0°C
Humidity	5%~95%
Altitude	Max. 2,000 m
Cooling Strategy	Natural Convection
Reliability & Certification	
Certificates	CE,RoHS,IEC62619,U L1 973, UL9540, UL9540A
Transportation	UN38.3
Ingress Rating	IP65

5 Technical parameters

- 1: Test Conditions: 100% Depth of Discharge (DOD), 0.2°C charge and discharge at +25±2°C for the battery at the beginning of its life. Usable energy may vary with different inverters.
- 2: Note: At 25±2°C of cell under 0.5C/0.5C test condition and 70% End of Life (EOL).
- 3: For long-term storage: Store battery cells in a temperature range of 5-45 °C, with relative humidity below 65%, and in a non-corrosive environment. Charge to 50-55% SOC before storage to prevent significant cycle life reduction.

NOTE

- When a level 1 alarm is triggered, the charge or discharge rate will be reduced.
- When a level 2 alarm is triggered, charge and discharge operations will be limited to 0A.
- Prolonged discharging at currents below 0.5A may lead to inaccuracies in the State of Charge(SOC) calculation.
- Storage SOC: Maintain a State of charge (SOC) between 30% and 50% for storage, and cycle the charge-discharge process every 6 months.
- Store the battery at a temperature range of 15-30 °C, for periods not exceeding one year.

6 Connection Port

The connection ports of the Soluna 10K Pack LV become visible once the cover plate is opened. Please refer to the attached pictures for further details.

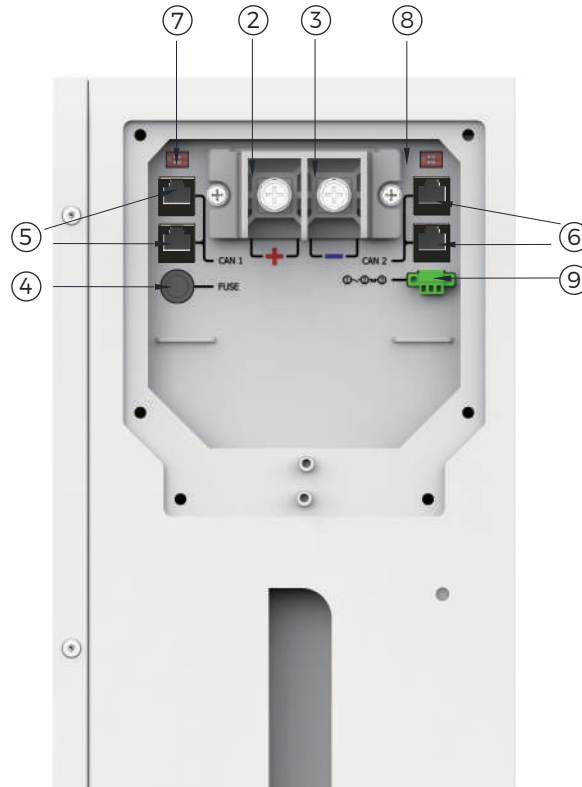

Number	Name	Description
1	Cover plate	This is a protective panel that safeguards the internal components of a device, ensuring that delicate parts are shielded from damage. It can usually be removed or opened to allow access for maintenance, inspection or connections to various ports and terminals.
2	Battery+	This is the positive terminal of the battery pack. It is used to connect the positive side of the electrical load or inverter.

3	Battery-	This is the negative terminal of the battery pack. It is used to connect the negative side of the electrical load or inverter.
4	FUSE	A safety device designed to protect the electrical circuit by interrupting power flow in case of excessive current.
5	CAN1 port	For internal communication (BMS) This port enables communication within the Battery Management System (BMS), ensuring efficient battery monitoring and management.
6	CAN2 port	For external communication (inverter) This port allows the battery pack to communicate with the inverter, facilitating power conversion and system integration.
7	CAN1 dial switch	A manual switch associated with the CAN1 port, used for configuring or adjusting communication settings.
8	CAN2 dial switch	A manual switch associated with the CAN2 port, allowing users to modify or configure communication settings.
9	Remote port	A port designed for connecting a remote control or other external devices, enabling extended operation or monitoring.

7 COM Communication Interface Definition

Once the cover plate of the Soluna 10K Pack LV is opened, users can view the connection ports of the battery. Please refer to the images below for detailed visuals.

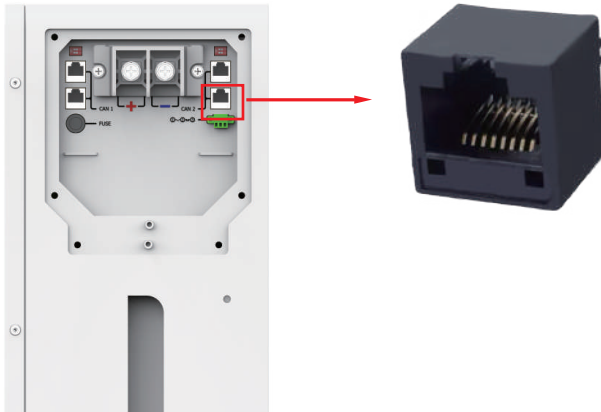

CAN1

1	2	3	4	5	6	7	8
RS485A (WiFi)	RS485B (WiFi)	5V	CAN-H	CAN-L	GND	—	—

CAN2

1	2	3	4	5	6	7	8
—	—	—	CAN-H	CAN-L	—	RS485A	RS485B

Remark:

- 1) CAN1 is used for BMS parameters monitoring
- 2) CAN2 is used for Inverter communication

8 LED Lights Definition

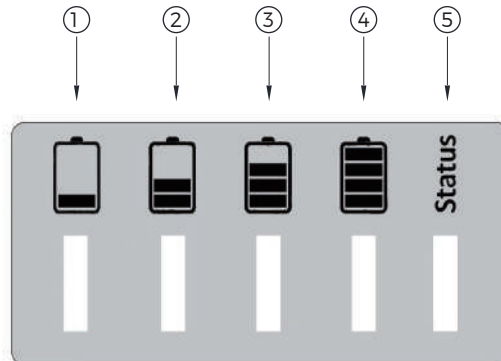

Figure 2.5 LED lights definition

Number	Name	Description
1	25% capacity light	Green light
2	50% capacity light	Green light
3	75% capacity light	Green light
4	100% capacity light	Green light
5	Status indicator light	Yellow light

Remark(Indicator Running State Information)

- **Push Button Switch**

A white light will turn on when the button is pressed.

- **Status Indicator Light**

Normal Operation: The light stays continuously on when there is no alarm.

Battery alarm: If the Soluna 10K Pack LV has an alarm, the orange status light flashes at a frequency of 1 S/time.









Communication failure: If the Soluna10K Pack LV cannot communicate with the inverter, the orange status light flashes for 3 seconds and turns off for 2 seconds.

Turn on heating: When the Soluna 10K Pack LV turns on the low-temperature heating function, the orange status light is always on, and the green indicator light scrolls from bottom to top in the form of a running light

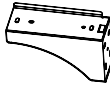
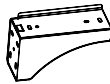
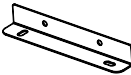
Start Upgrade: When the Soluna 10K Pack LV is upgrading its software, all indicators flash simultaneously.

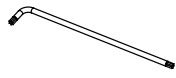
9.1 Packing List

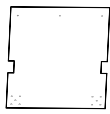
The following table lists the numbers of each item included. If anything is damaged or missing, contact SOLUNA or your distributor.

Item	Name	Description	Qty (pcs)	Photo
1	Soluna 10K Pack LV	The battery	1	
2	Wall fixed support frame	Sturdy wall-mounted frame for structural equipment support.	1	
3	Foot hanging ear-left	Left-side mounting bracket/ear for secure equipment attachment to support frame	1	
4	Foot hanging ear-right	A right-side bracket or ear for attaching equipment to the support frame.	1	
5	Bottom corner support frame-left	A left-side corner support frame for stabilizing and reinforcing the equipment's bottom structure.	2	
6	Expansion screws	6mm x 16mm metric screws for assembling or securing equipment parts.	11	
7	Wrench	Tool for tightening or loosening nuts, bolts, or screws.	1	
8	Screws-M6*16	Screws for anchoring into walls or surfaces to securely mount the support frame or equipment.	7	
9	Positioning cardboard	Cardboard template for marking drilling points and mounting locations during installation.	1	
10	Communication cable(2m)	2-meter cable for communication and data transmission between equipment and devices.	2	

9.2 Installation Materials

These installation materials shall be prepared by installers.

- Charging cables.
- Communication cable.

9.3 Installation Location

We recommend that Soluna 10K Pack LV is used in Soluna Home energy storage systems, if not, please Make sure that the installation location meets the following conditions:

- The building is designed to withstand earthquakes.
- The location is far away from the sea, to avoid salt water and humidity.
- The floor is flat and level.
- There are no flammable or explosive materials nearby.
- The ambient temperature is between 15 and 30°C.
- The temperature and humidity stays at a constant level.
- There is minimal dust and dirt in the area.
- There are no corrosive gases present, including ammonia and acid vapor.
- Do not place the battery system in direct sun light. it is suggested to build sunshade equipment In cold area the heating system is required.



If the ambient temperature is outside the operating range, the battery pack stops operating to protect itself. The optimal temperature range for the battery pack to operate is 15°C to 30°C. Frequent exposure to harsh temperatures may deteriorate the performance and lifetime of the battery pack.

9.4 Installation Tools Requirements

The following tools are required to install the battery pack:

Remark:

Use properly insulated tools to prevent accidental electric shock or short circuits.

Item	Photo	Name
1		Phillips-screwdriver bit
2		Wire cutters
3		Wire stripper
4		Tape measure
5		Pistol drill
6		Spirit level
7		Electrical insulating tape
8		Multimeter
9		Marker pen

When handling the battery pack ,it is essential to wear the appropriate safety gear to protectagainst potential hazards ,installers must adhere to the relevant requirements of international standards ,such as IEC 60364 ,or comply with domestic legislation.

1		Safety goggles
2		Safety shoes
3		Insulated gloves

9.5 Wiring Specification

In order to standardize the wiring specification of Soluna 10K Pack LV, the following requirements are required for connecting wires of Soluna 10K Pack LV.

Battery Wire	Communication Cable
It is recommended to use 70mm ² (2/0 AWG) of conductor with double insulation.	It is recommended to use standard communication cable with shielding function.

9.6 Installation Method

Wall-Mounted Installation

Step 1: Mark Mounting Hole Locations

Use the hole on the positioning cardboard to directly drill a hole at a suitable height on the wall. The hole size is \varnothing 10mm and the drilling depth is 60mm.

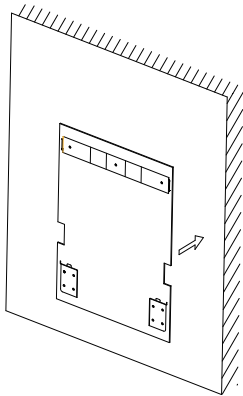

Step 2: Drill Holes

Use an impact drill to drill holes at the marked locations using the following dimensions. The hole size is \varnothing 10mm and the drilling depth is 60mm.

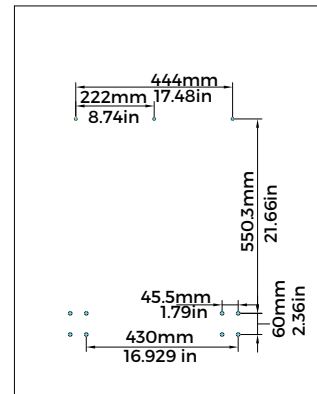

Step 3: Install Wall Bracket

Use 3PCS expansion screws to install the wall bracket to the wall, and use 8PCS M6 expansion screws to fix the base support frame.

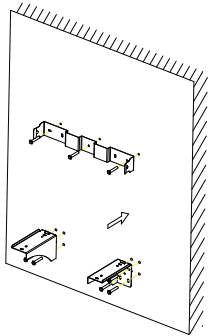

Step 4: Mount the Battery

Place the product on the wall bracket and fix it with M6 screws on both sides. Fix the base support bracket with M6 screws on both sides. The torque is 6.5~7.9Nm.

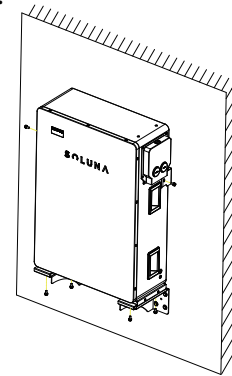

Step 5: Connect Wiring

After securing the product, install the wiring harness.

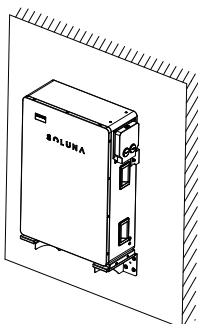

9.7 Installation Method

Ground Installation

Step 1: Attach the Bracket to the Product

As shown below, use M6 screws to tighten the side mounting ears. The torque is 6.5-7.9Nm.

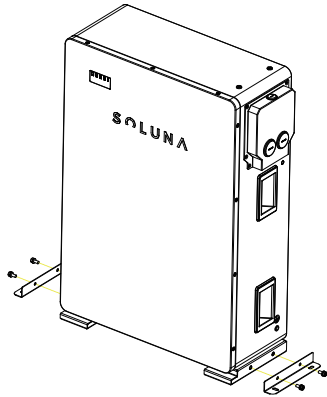

Step 2: Drill Holes for Mounting

Use an impact drill to drill a hole at the marked position with a size of $\square 10$ mm and a drilling depth of 60mm.

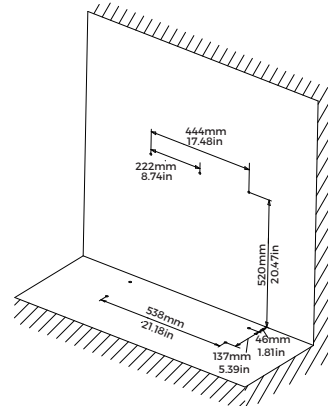

Step 3: Install the Wall Bracket

Use 3PCS expansion screws to install the wall bracket to the wall.

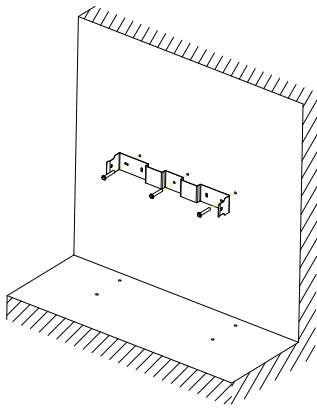

Step 4: Mount the Product

Place the product on the wall bracket and secure it with M6 screws on both sides, torque 6.5-7.9 Nm. Secure the feet with M6 expansion screws on both sides.

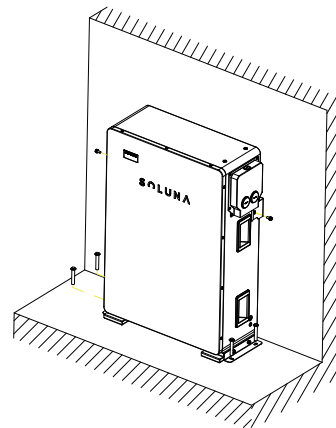

Step 5: Connect the Wiring

After securing the product, install the wiring harness

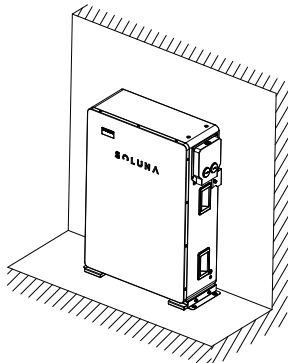

9.8 CAN communication connection

Please find the following drawing for details.

1x Battery

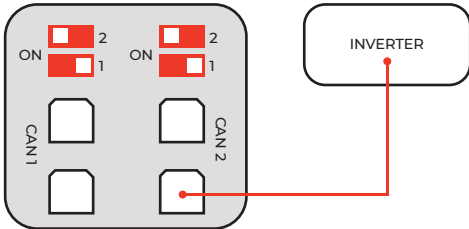

2x Battery

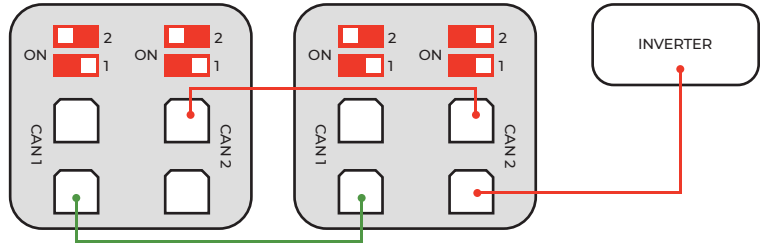

3x Battery

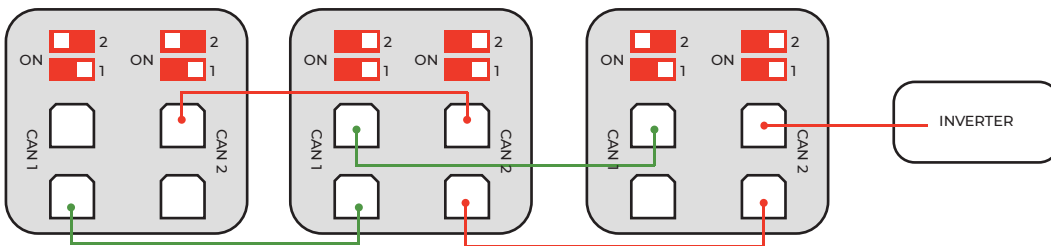

(4-12)x Battery

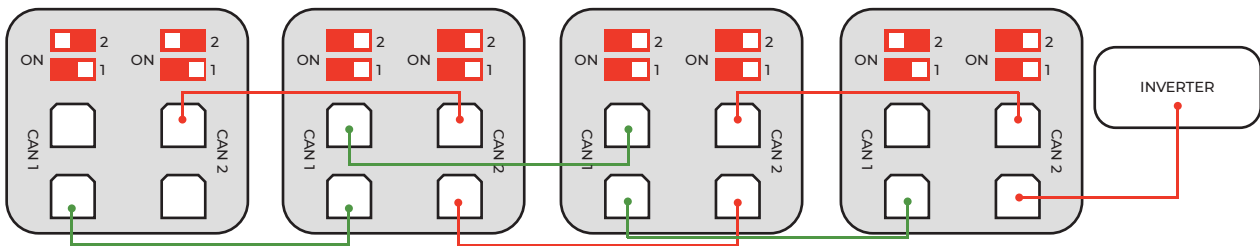

Please follow the diagram to adjust the switches, ensuring proper configuration

- CAN 1 Connection Link
- CAN 2 Connection Link

10 Electrical connection

Standalone

- Communication cable
- Battery positive pole
- Battery negative pole

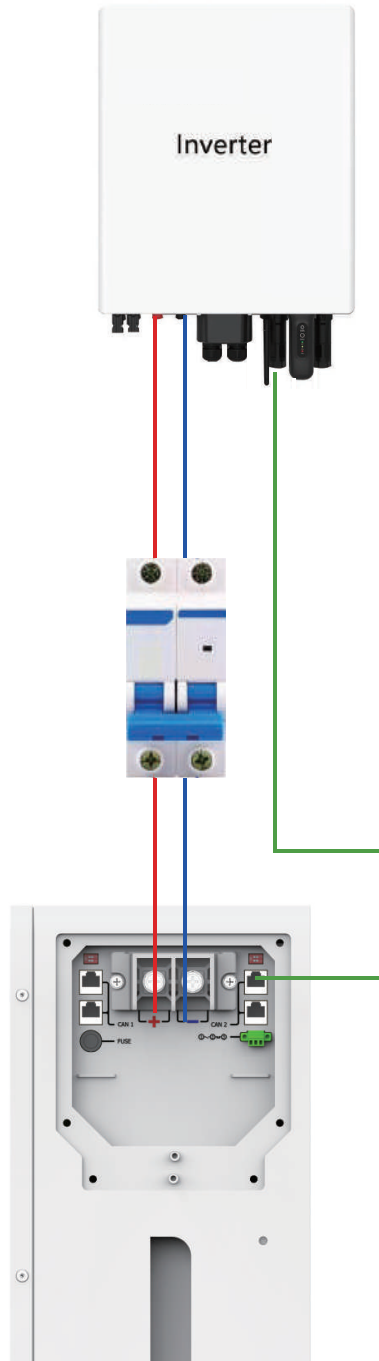

- 1) The "2" on the DIP switch of the first battery CAN1 and CAN2 port should be turned to the "ON" position.

10 Electrical connection

Multiple Clusters

- Communication cable
- Battery positive pole
- Battery negative pole

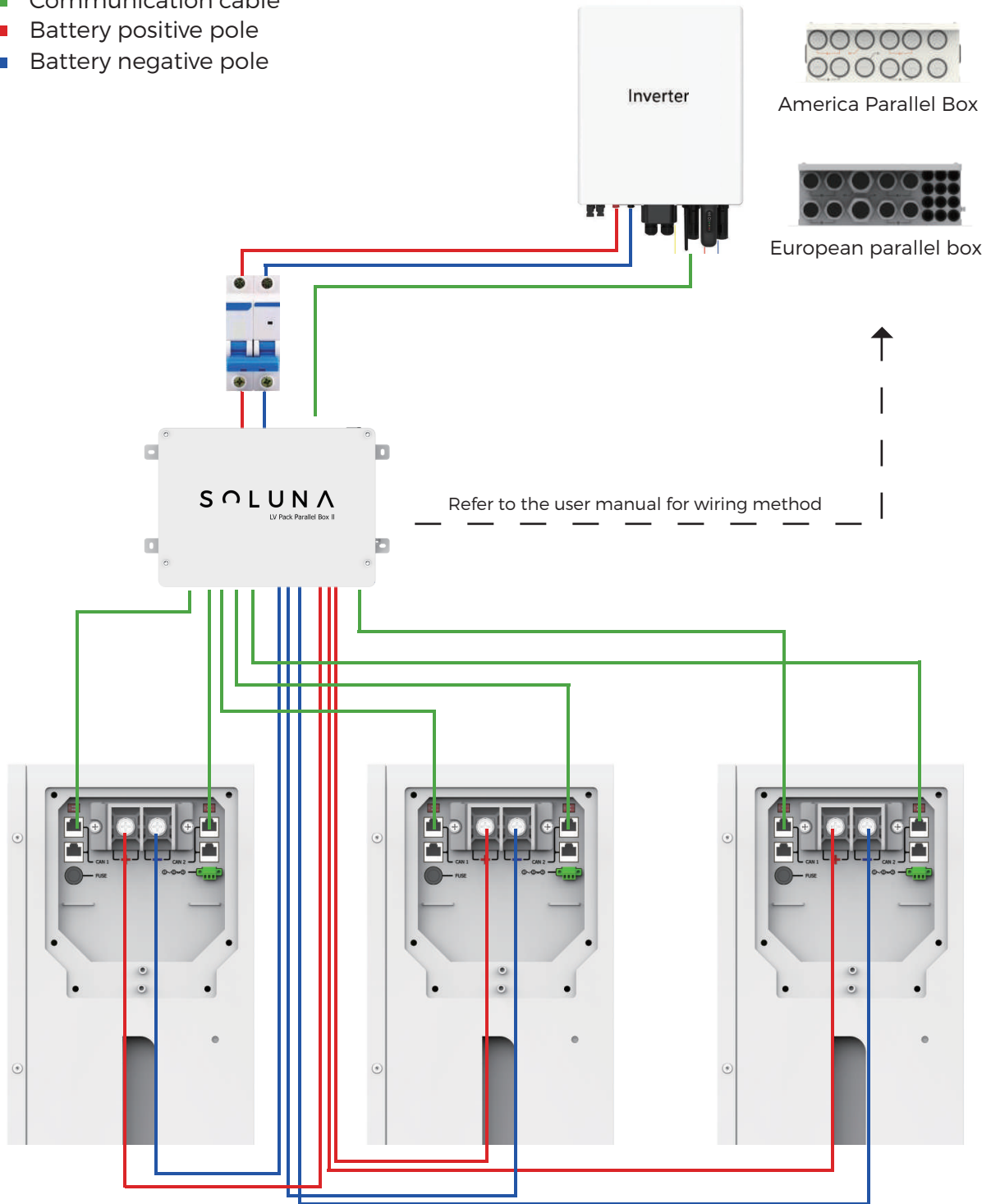

- 1) The DIP switch of port CAN1 of the first parallel box should be set to the "on" position.
- 2) The DIP switches for ports CAN1 and CAN2 of the last parallel box should be set to the "on" position

11 How to operate Soluna 10K Pack LV

There are two ways to start the Soluna 10K Pack LV. Below are the details for each mode:

Starting Mode 1 (Factory Default)

- Connect Pin 2 and Pin 3 on the 3-pin jack plug.
- Press the metal button switch.
- The Soluna 10K Pack LV will start operating within 25 seconds.
- If no communication is established within 5 minutes, the system will stop outputting power.

Starting Mode 2

- Install a switch between Pin 1 and Pin 2 on the 3-pin jack plug.
- Turn the switch on.
- The Soluna 10K Pack LV will start operating within 25 seconds.
- If no communication is established within 5 minutes, the system will stop outputting power.

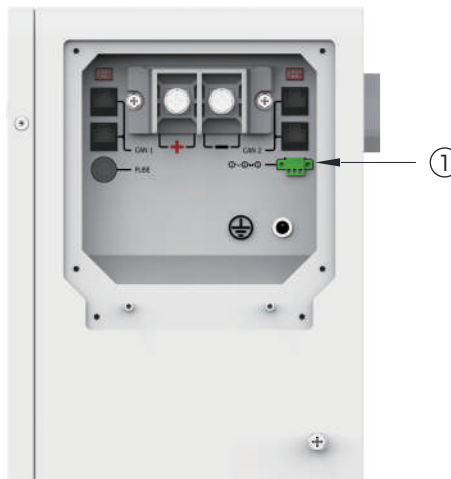

Number	Name	Description
1	3pin jack plug	Controlled current startup with differentiated startup modes

12 Trouble shooting guideline

Please find the following table for details

Phenomenon	LED Alarm	Possible root cause	How to target the root cause	Solution
No communication between battery and inverter	LED is off	1) Compatible inverter firmware is not the latest version.	Please check the inverter APP or LCD/LED for firmware reversion.	Update inverter's firmware.
		2) The battery firmware is incompatible with the inverter manufacturer.	Please use canbus tool box or Soluna smart energy cloud to check firmware reversion.	Update battery's firmware.
		3) Installer didn't choose Soluna battery correctly on inverter side.	Please check if the selection of battery is correct or not.	Re-select Soluna battery on inverter.
		4) Communication cable is loose or not correct.	Please check the communication cable status.	Re-plug or change the communication cable.
		5) Terminal resistor dial incorrectly.	Check the position of resistor dial.	Redial the terminal resistor.
		6) Inverter hardware fault.	Please change another inverter to try.	Redial the terminal resistor.
		7) Battery hardware fault.	Please change another battery to try.	Contact Soluna for additional support and next steps.
Battery can't be charged or discharged	N/A	1) Inverter setting incorrect such as disable the charging or discharging, and time setting, etc.	Check the inverter setting.	Reset the inverter setting.
		2) Inverter can't read Soluna battery type correctly.	Please check the battery type of product and product name shown in inverter side.	Contact with Inverter manufacturer or Soluna for additional support and next steps.
		3) Inverter hardware fault.	Please change another inverter to try.	Contact with Inverter manufacturer.
		4) Battery hardware fault.	Please change another battery to try.	Contact with Soluna for additional support and next steps.

12 Trouble shooting guideline

Please find the following table for details

Phenomenon	LED Alarm	Possible root cause	How to target the root cause	Solution
Battery is empty over discharged	LED is off	1) Off-grid installation-battery can't be charged for over 2 weeks due to no production of PV system(rainy season, snow season, or PV system fault).	Check the battery voltage through the reserved service port. If 10K LV is less than 40V, please turn off the battery and contact with Soluna.	Contact with Soluna for additional support and next steps.
		2) Customer didn't turn off the battery or over 2 weeks in the scenario such as: A. Installation is not finished. B. System failure, not running.	Check the battery voltage through the reserved service port. If 10K LV is less than 40V, please turn off the battery and contact with Soluna.	Contact with Soluna for additional support and next steps.
		3) The battery was stocked for over 2 years without charging	Check the battery voltage through the reserved service port. If 10K LV is less than 40V, please turn off the battery and contact with Soluna.	Contact with Soluna for additional support and next steps.
Battery is not working correct in parallel installation	N/A	1) Battery communication cable is loose or not correct.	Check the communication cable status.	Re-plug or change the communication cable.
		2) Battery power cable is loose or not connected correctly.	Check the battery power cable.	Fasten the power cable .
		3) Battery communication port resistor missing or wrong dial	Check the resistor dialing.	Plug the communication port resistor or re-dial.
		4) Battery firmware is not the latest.	Please use canbus tool box or Soluna e cloud to check firmware reversion.	Update the firmware to the latest version.

12 Trouble shooting guideline

Phenomenon	LED Alarm	Possible root cause	How to target the root cause	Solution
Battery wifi connecting failure	N/A	1) The Wifi network is not compatible	Check the end user network type.	Please choose only 2.4G wifi mode.
		2) Connecting fail	APP will remind.	Please read the SOP of wifi setting up.
		3) System establish failed due to S/N valid	APP will remind.	Contact with Soluna for additional support and next steps.
Minor Alarm message on Soluna monitoring system	N/A	1) Battery reach to 1st level alarm such as battery over voltage	No need further action.	Please ignore it, this alarm message is only used for inverter strategy. The power of charging/ discharging will be limited.
Moderate Alarm message on Soluna monitoring system	N/A	2) Battery reach to 2nd level alarm such as battery over voltage	No need further action.	Please ignore it, this alarm message is only used for inverter strategy. The power of charging/ discharging will be limited.
Protection Alarm message on Soluna monitoring system	LED is blinking or yellow	3) Battery reach to 3rd level alarm such as battery over voltage	1) Please check the inverter LCD/LED or APP for the battery alarm information. 2) Please check the Soluna ecloud for battery alarm information.	Battery will shut down, please contact with Soluna for additional support and next steps.

13 Depth of Discharge(DOD) Setting for Inverter

To ensure optimal performance and smooth operation of the battery, we recommend the following settings for the inverter:

On-Grid DOD: 80%

Off-Grid DOD: 70%

In energy storage systems, reducing the depth of discharge (DOD) of lithium batteries is aimed at improving system economics, extending battery life, enhancing safety, and optimizing performance. Below are the specific reasons:

1. Extending Battery Life

- The cycle life of lithium batteries is closely related to the depth of discharge. Deep discharge (e.g., 80%-100% DOD) accelerates battery aging, leading to faster capacity degradation.
- Reducing DOD (e.g., controlling it between 20%-80%) can significantly extend the battery's cycle life, thereby lowering long-term maintenance and replacement costs for the energy storage system.

2. Improving System Economics

- Batteries account for a significant portion of the cost in energy storage systems. Extending battery life means reducing the frequency of battery replacements and lowering the total lifecycle cost.
- Although reducing DOD decreases the available energy per cycle, the overall energy throughput (total charge-discharge capacity) may increase by extending battery life, there by improving economic efficiency.

3. Enhancing Safety

- Deep discharge increases the risk of over-discharge, causing the battery voltage to drop too low, which may lead to irreversible chemical damage (e.g., dissolution of the copper current collector in the anode).
- Reducing DOD can prevent over-discharge, minimize safety risks such as thermal runaway, and ensure stable operation of the energy storage system.

14 Register on the Website after Installation

After completing the installation of the battery system and confirming that it is operating normally, please log in to the Soluna official website to register your product installation and usage details. This registration is required for the product warranty to take effect. Follow the on-screen instructions on the website to complete the registration process.

<https://soluna.co> → SUPPORT & SERVICE → Warranty registration

If you have any questions, feedback, or need assistance, please feel free to reach out to us.
We are here to help!

Soluna (Shanghai) Co.,Ltd

Add: No.3492 Jinqian Road, Shanghai, China 201406

Tel: +86-21-57475835

Email: sales@solunabattery.com

Web: www.solunabattery.com

Social media: <https://www.linkedin.com/company/solunabattery>