

User Manual

Battery Energy Storage System

Soluna Bes 5K Pack

A.2

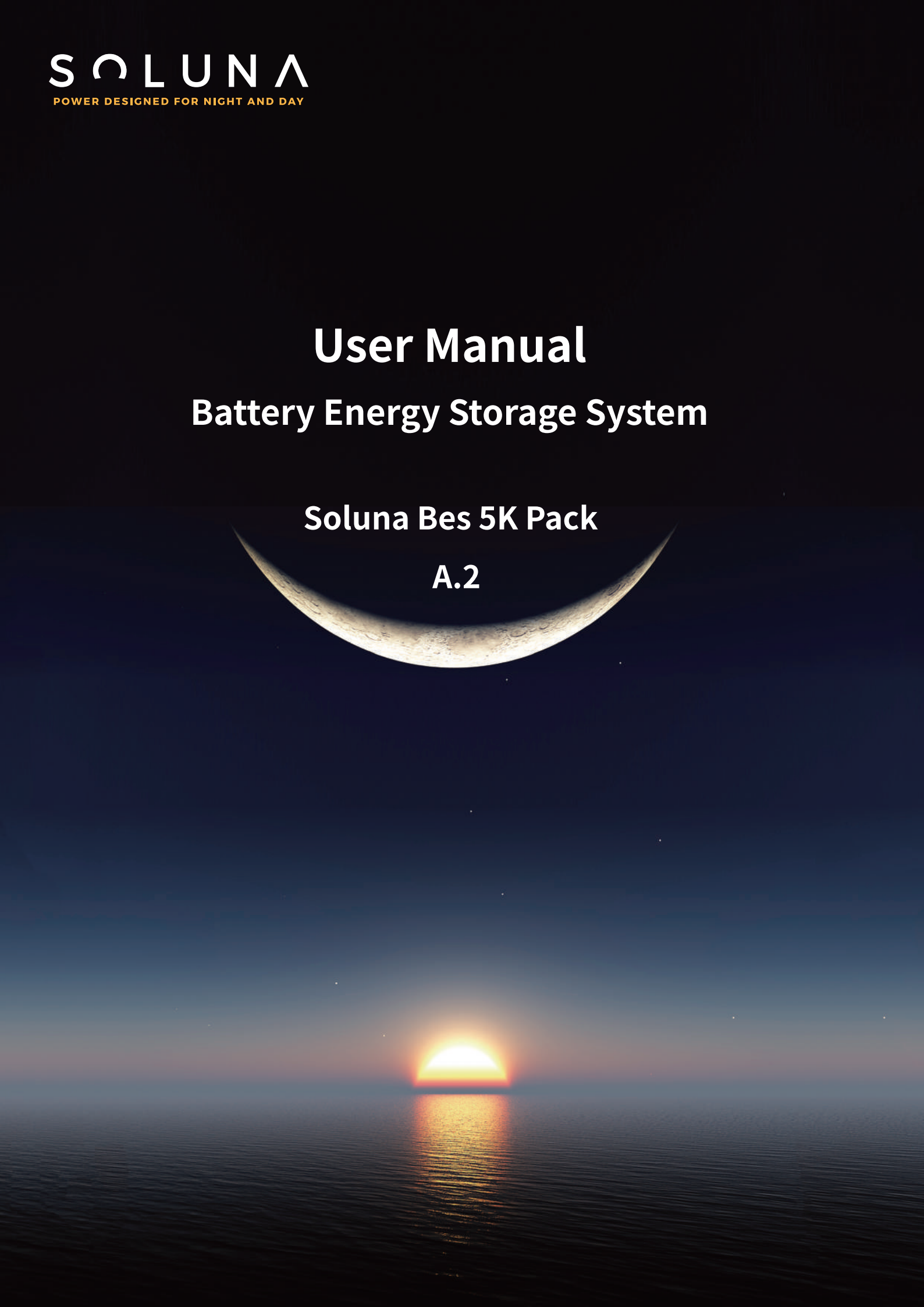

About this Specification

This manual provides comprehensive instructions for installing the Soluna Bes 5K Pack. It is imperative to thoroughly read this manual before attempting to install the product and to follow the instructions diligently throughout the installation process.

If you have any doubts about the requirements, recommendations, or safety procedures described in this manual, please contact Soluna immediately for advice and clarification.

The information contained in this manual is accurate at the time of publication. However, due to ongoing updates to product design and technical specifications, our company reserves the right to make changes at any time without prior notice. Additionally, the illustrations included in this manual are intended to aid in explaining system configuration concepts and installation instructions. The items depicted in the illustrations may differ from the actual items at the installation site.

SOLUNA (SHANGHAI) CO.,LTD reserves the copyright of this document.

1. Introduction.....	05
2. Features.....	06
3. Safety Precautions.....	07
3.1 Warning Sign	07
3.2 Safety Instructions.....	08
3.2.1 Risks of Explosion.....	08
3.2.2 Risks of fire	08
3.2.3 Risks of electric shock.....	08
3.2.4 Risks of damage to the battery pack	08
3.3 Battery handling guide.....	09
3.4 Response to emergency situations.....	09
3.4.1 Leaking batteries	09
3.4.2 Inhalation.....	09
3.4.3 Eye contact	09
3.4.4 Skin contact.....	10
3.4.5 Ingestion.....	10
3.4.6 Fire.....	10
3.4.7 Wet batteries.....	10
3.4.8 Damaged batteries	11
3.5 Qualified installers.....	11
4. Appearance.....	12
5. Technical parameters.....	14
6. Connection Port	16
7 COM Communication Interface Definition	18
8 LED Lights Definition.....	19
9 Master & Slave Setting.....	20
10 PROT.....	24
11 Installation.....	28
11.1 Packing Lists.....	28
11.2 Installation Materials.....	29
11.3 Installation Location.....	29
11.4 Installation Tools Requirements	30
11.5 Wiring Specification.....	31

Contents

11.6 Battery Units Parallel Communication Connection	32
11.7 Standalone.....	33
11.8 Installation angle requirement.....	34
11.9 Installation Method	35
12. No communication mode setting parameters	38
13. Trouble Shooting Guideline.....	39
14. DOD setting of inverter.....	42
15. Register on the Website after Installation	43
16. Contact us.....	44

1 Introduction

The Soluna Bes 5K Pack is an advanced LFP lithium battery product designed to meet the highest standards of performance and safety. Equipped with a sophisticated Battery Management System (BMS), this high-voltage battery module features CAN/RS485 communication for seamless integration and monitoring. It includes comprehensive protections against under-voltage, over-voltage, over-current, over-temperature, and under-temperature, ensuring optimal performance and safety under various conditions.

With its high energy density, long lifespan, and robust reliability, the Soluna Bes 5K Pack stands out as a green environmental product you can trust. Its innovative design not only enhances efficiency but also contributes to sustainability, making it an ideal choice for Backup Power, Micro-grid Solutions, and Small Industrial & Commercial Energy Storage Systems.













Features

- **Excellent Safety Performance**
Ensures the highest level of safety under various conditions.
- **Long Cycle Life**
Designed for extended usage without significant performance degradation.
- **Support CAN/RS485**
Allows seamless integration and communication with other systems.
- **Parallel Interconnection**
Enables the connection of several systems in parallel for increased capacity.
- **Expandable Battery Units**
Provides flexibility to scale the system as needed.
- **Backup Power**
Reliable power supply during outages.
- **Micro-grid**
Supports independent and sustainable energy systems.
- **Home Energy Storage System**
Efficiently stores energy for residential use.

3 Safety Precautions

3.1 Warning Signs

Warning signs are essential indicators designed to alert you to conditions that could result in severe injury or significant damage to the device. They serve as critical reminders to exercise caution and take necessary precautions to prevent hazardous situations. The table below outlines the warning signs used in this manual and their meanings:

Sign	Description
	High Voltage Warning: This battery pack operates at high voltage, which can cause severe injury due to electric shock.
	Correct Polarity: Ensure the battery polarity is correctly connected.
	Fire Safety: Keep the battery pack away from open flames or ignition sources.
	Child Safety: Store the battery pack out of reach of children.
	Installation Manual: Thoroughly read the manual before installing and operating the battery pack.
	Heavy Weight Warning: The battery pack is heavy, and improper handling may result in severe injury. Utilize proper lifting techniques.
	Electrolyte Leakage: The battery pack may leak corrosive electrolyte. Handle with care and adhere to appropriate safety procedures.
	Explosion Risk: The battery pack may explode under certain conditions.
	Disposal Instructions: Do not dispose of the battery pack with household waste at the end of its working life. Follow local regulations for disposal.
	Compliance Requirement: Failure to follow the provided requirements and guidelines may lead to physical injury or damage to the device.
	Do not short circuit.
	Grounding conductor This symbol indicates the position for connecting a grounding conductor.

3.2 Safety Instructions

For safety reasons, it is crucial that installers thoroughly familiarize themselves with the contents of this manual and all associated warnings prior to commencing the installation.



General Safety Precautions

Failure to adhere to the precautions outlined in this section can result in serious injury or property damage. Please observe the following safety guidelines:

3.2.1 Risks of Explosion

- Avoid subjecting the battery pack to strong impacts.
- Do not crush or puncture the battery pack.
- Never dispose of the battery pack in a fire.

3.2.2 Risks of Fire

- Do not expose the battery pack to temperatures exceeding 60°C.
- Keep the battery pack away from heat sources, such as fireplaces.
- Avoid exposing the battery pack to direct sunlight.
- Ensure the battery connectors do not come into contact with conductive objects like wires.

3.2.3 Risks of Electric Shock

- Refrain from disassembling the battery pack.
- Do not touch the battery pack with wet hands.
- Keep the battery pack away from moisture or liquids
- Ensure the battery pack is kept away from children and animals.

3.2.4 Risks of Damage to the Battery Pack

- Prevent the battery pack from coming into contact with any liquids.

3.3 Battery Handling Guide

- Use the battery pack strictly as directed in the manual.
- Do not use the battery pack if it appears defective, cracked, broken, or fails to operate correctly.
- Do not attempt to open, disassemble, repair, tamper with, or modify the battery pack as it is not user serviceable.
- Handle the battery pack with care during transportation to avoid damage.
- Avoid impacting, pulling, dragging, or stepping on the battery pack.

3.4 Response to Emergency Situations

The Soluna Bes 5K Pack consists of multiple batteries designed to prevent hazards resulting from failures. However, Soluna cannot guarantee absolute safety. Please familiarize yourself with the following emergency procedure

3.4.1 Leaking Batteries

If the battery pack leaks electrolyte, avoid contact with the leaking liquid or gas. Electrolyte is corrosive and contact may cause skin irritation and chemical burns. If exposed to the leaked substance, follow these steps:

3.4.2 Inhalation

- Evacuate the contaminated area immediately.
- Seek medical attention without delay

3.4.3 Eye Contact

- Rinse eyes with flowing water for at least 15 minutes.
- Seek medical attention immediately.

3.4.4 Skin Contact

- Wash the affected area thoroughly with soap and water.
- Seek medical attention immediately.

3.4.5 Ingestion

- Induce vomiting.
- Seek medical attention immediately.

3.4.6 Fire Response Procedures

In the event of a fire, always have an ABC or carbon dioxide extinguisher on hand.



The battery pack may ignite if heated above 150°C. If a fire occurs where the battery pack is installed, follow these steps:

- **Extinguish Early**

Attempt to extinguish the fire before the battery pack ignites.

- **Safe Relocation**

If extinguishing is not possible but time allows, move the battery pack to a safe area before it catches fire.

- **Evacuate**

If the battery pack has already caught fire, do not attempt to extinguish it. Evacuate the area immediately.



Caution: If the battery catches fire, it will emit noxious and poisonous gases. Do not approach the fire.

3.4.7 Wet Batteries

If the battery pack becomes wet or submerged in water, do not attempt to access it. Contact Soluna or your distributor for technical assistance immediately.

3.4.8 Damaged Batteries

Damaged batteries are hazardous and must be handled with extreme caution. They are unfit for use and may pose a danger to people or property.

If the battery pack appears damaged, pack it in its original container and return it to Soluna or your distributor.



Leakage and Flammability: Damaged batteries may leak electrolyte or produce flammable gas. If you suspect such damage, contact Soluna for advice and information immediately.

3.5 Qualified Installers

This manual, along with the tasks and procedures described herein, is intended for use by skilled professionals only. A skilled professional is defined as a trained and qualified electrician or installer who possesses all of the following skills and experience:

- **Functional Knowledge**

Understanding of the principles and operation of on-grid systems.

- **Risk Awareness**

Awareness of the dangers and risks associated with installing and using electrical devices and the acceptable methods for mitigating these risks.

- **Installation Proficiency**

Expertise in the installation of electrical devices.

- **Adherence to Guidelines**

Knowledge of and compliance with this manual, including all safety precautions and best practices.

- **Battery Maintenance**

Only authorized personnel should perform maintenance. Turn off the battery before maintenance. Periodically check voltage, SOC, and cables for damage or wear. Perform balancing maintenance (fully charge) every three months.

- **Installation Environment Requirements**

Avoid flammable, explosive, or corrosive materials. Keep out of children's reach and avoid high temperatures. Ensure proper ventilation and avoid electromagnetic interference. Install in a sheltered, well-ventilated area, within the appropriate temperature and humidity range, and below 2000 meters altitude.

4 Appearance

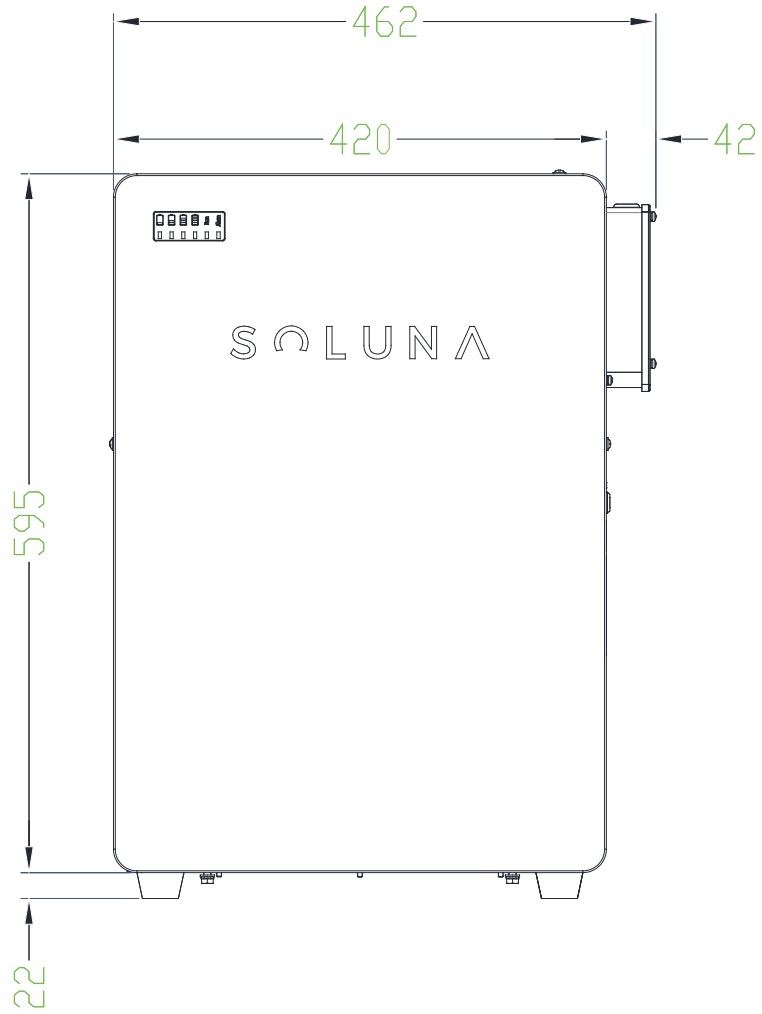

Width	157	mm
Depth	462	mm
Height	617	mm
Weight	48	kg

4 Appearance

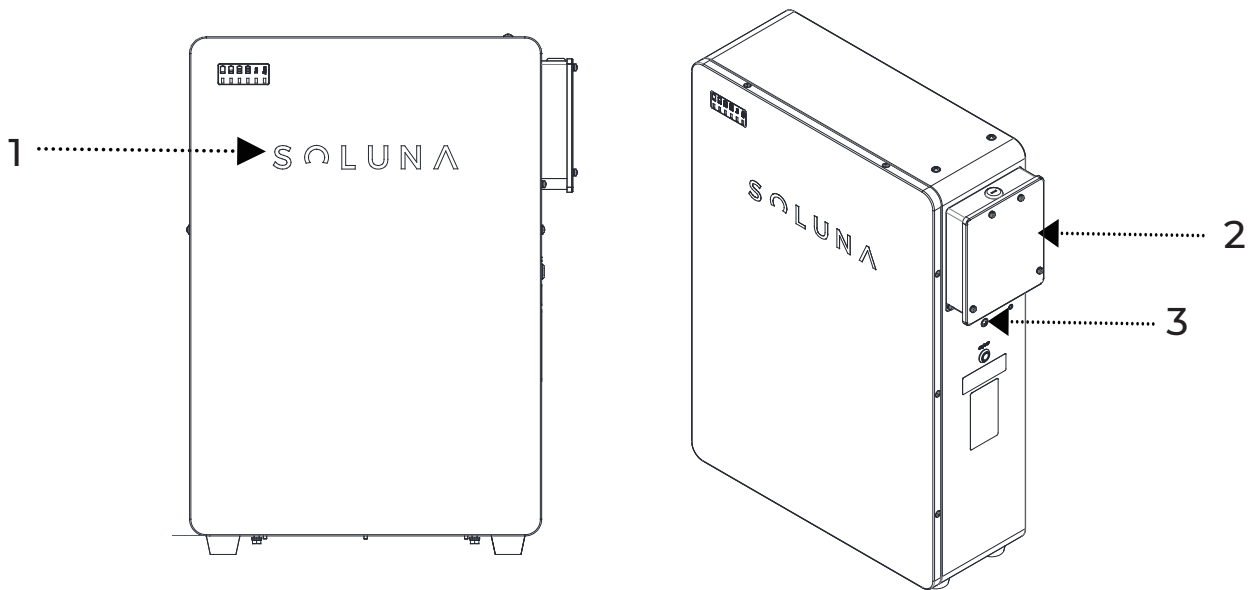

Number	Name	Describe
1	Logo	The brand's emblem or identifier.
2	Entry	The main access point or interface for the product.
3	Install the handle	Parts used to operate the box lifting.

5 Technical parameters

Physical Characteristics	
Width	157 mm
Depth	462 mm
Height	617 mm
Weight	48 kg
Electrical Characteristics	
Battery type	LFP
Total Energy Capacity	5.12kWh
Usable Energy Capacity	4.60kWh
Battery Capacity (Nominal)	100Ah
Nominal Voltage	51.2V
Usable Voltage Range	48~57.6V
Charge Current (Recommended)	75A
Discharge Current (Recommended)	75A
Max. Continuous Charge Current	75A
Max. Continuous Discharge Current	100A
Recommended Depth of Discharge	80%
Max. Depth of Discharge	90%
Cycle life @25 (Standard charge and discharge)	≥8000
Internal resistance	≤60mΩ
DC Disconnect	MOS Fuse
Warranty	

5 Technical parameters

10 years	
BMS	
Power consumption	<3W (work), <100mW (sleep)
Monitoring parameters	System Voltage System Current Cell Voltage Cell Temperature
Communication	CAN / RS485
Protection	Over Voltage, Under Voltage Over Current, Over Temperature Under Temperature
System Configuration	
Module parallel	1~32 Parallel
Operating Conditions	
Installation Location	Indoor / Outdoor
Operating Temperature	Charge: 0~50 °C, Discharge: -20~60 °C
Operating Temperature (Recommended)	15~30 °C
Storage Temperature	-20~60 °C
Humidity	5%~95%
Altitude	Max. 2,000 m
Cooling Strategy	Natural Convection
Reliability & Certification	
Certificates	Cell:UL1642,Battery Module:RoHS
Transportation	UN38.3
Ingress Rating	IP65

6 Connection Port

Once the cover plate of the Soluna Bes 5K Pack is opened, users can view the connection ports of the battery. Please refer to the images below for detailed visuals.

Remark:

1	Screw torque standard: 0.24-0.36N*m
2	Screw torque standard: 4.40-5.20N*m

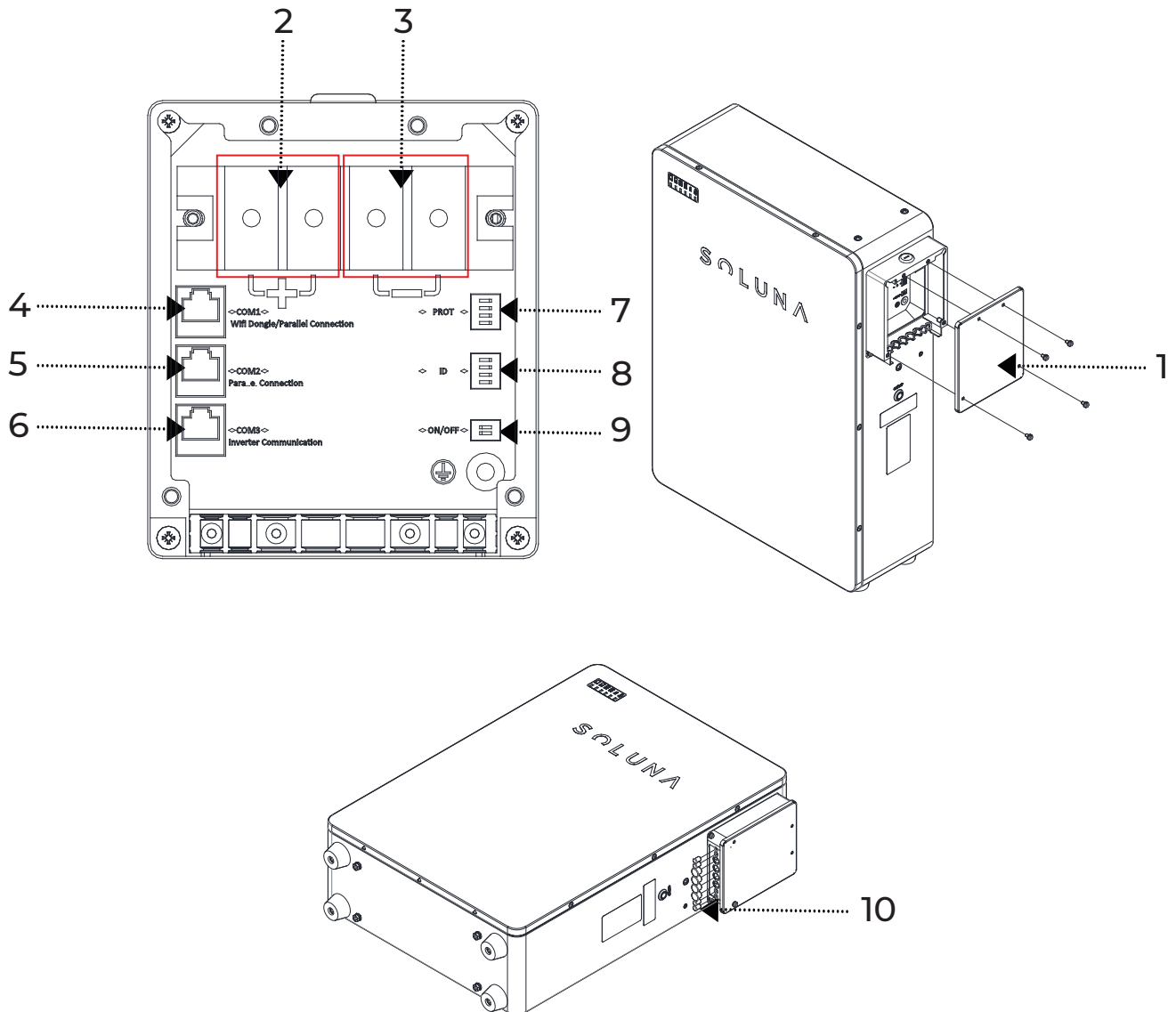

Number	Name	Describe
1	upper cover	/
2	Battery+	Battery Positive (Battery+): Connects to the positive terminal of the battery. Terminal rated current: 100A
3	Battery-	Battery Negative (Battery-): Connects to the negative terminal of the battery. Terminal rated current: 100A
4	COM 1	Communication Port 1 (COM 1): Battery parallel + WiFi stick
5	COM 2	Communication Port 2 (COM 2): Battery parallel + WiFi stick
6	COM 3	Communication Port 3 (COM 3): Communicate with the inverter
7	PROT	Protection Port (PROT): Select the protocol with the inverter and shake hands with the inverter
8	ID	Identification Port (ID): Used to identify battery module address
9	DIP	Please refer to pages 33 and 34
10	Rubber Plug	/

After the wiring harness is installed, the holes where the wiring harness is not installed need to be plugged with rubber plugs

7 COM Communication Interface Definition

Once the cover plate of the Soluna Bes 5K Pack is opened, users can view the connection ports of the battery. Please refer to the images below for detailed visuals.

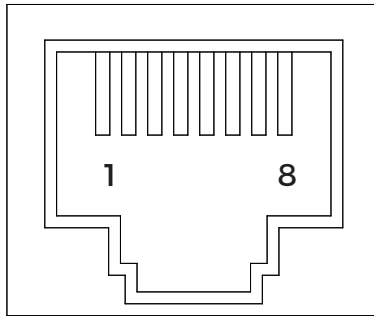

COM1

1	2	3	4	5	6	7	8
RS-485A (WIFI)	RS-485B (WIFI)	12V	CAN-H	CAN-L	GND	RS-485A	RS-485B

COM2

1	2	3	4	5	6	7	8
RS-485A (WIFI)	RS-485B (WIFI)	12V	CAN-H	CAN-L	GND	RS-485A	RS-485B

COM3

1	2	3	4	5	6	7	8
NC	NC	NC	CAN-H	CAN-L	NC	RS-485A	RS-485B

- 1) COM 1 Wifi Dongle/Parallel Connection
- 2) COM 2 Parallel Connection
- 3) COM 3 Inverter Communication

8 LED Lights Definition

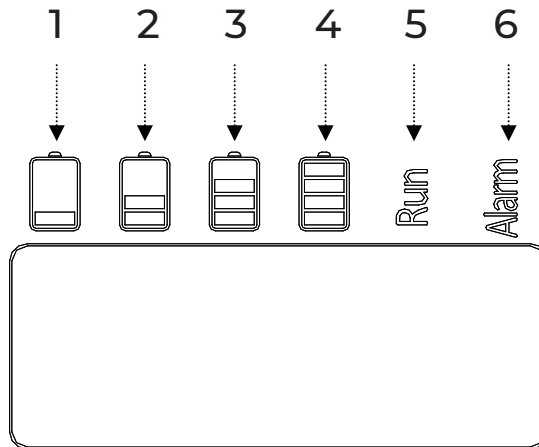

Number	Name	Describe
1	25% capacity indicator	Green light
2	50% capacity indicator	Green light
3	75% capacity indicator	Green light
4	100% capacity indicator	Green light
5	Run indicator light	Green light
6	Alarm indicator light	Yellow light

9 Master & Slave Setting



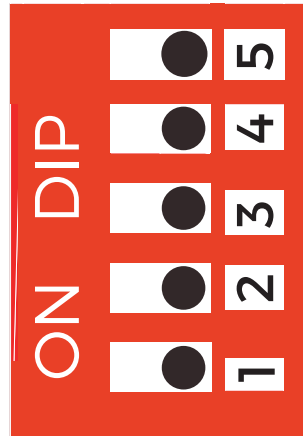



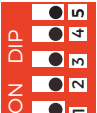
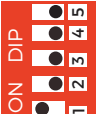
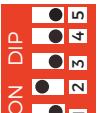
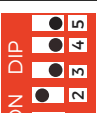

First, locate the ID on the operation panel. When the battery packs are connected in parallel, the address of each battery module can be set using the dial switch. Each address is unique and independent





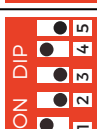
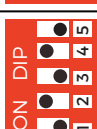
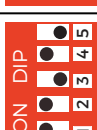
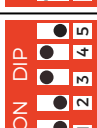

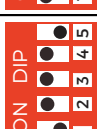

ID

Address	Location of Dial Switch		
0		00000	Master 1
1		00001	Set as Pack 2
2		00010	Set as Pack 3
3		00011	Set as Pack 4

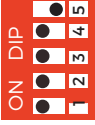
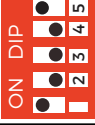
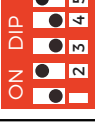

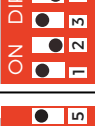

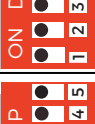
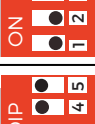
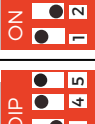
9 Master & Slave Setting

4		00100	Set as Pack 5
5		00101	Set as Pack 6
6		00110	Set as Pack 7
7		00111	Set as Pack 8
8		01000	Set as Pack 9
9		01001	Set as Pack 10
10		01010	Set as Pack 11
11		01011	Set as Pack 12
12		01100	Set as Pack 13
13		01101	Set as Pack 14
14		01110	Set as Pack 15
15		01111	Set as Pack 16

9 Master & Slave Setting

16		10000	Set as Pack 17
17		10001	Set as Pack 18
18		10010	Set as Pack 19
19		10011	Set as Pack 20
20		10100	Set as Pack 21
21		10101	Set as Pack 22
22		10110	Set as Pack 23
23		10111	Set as Pack 24
24		11000	Set as Pack 25
25		11001	Set as Pack 26
26		11010	Set as Pack 27

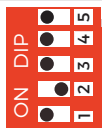
9 Master & Slave Setting



27		11011	Set as Pack 28
28		11100	Set as Pack 29
29		11101	Set as Pack 30
30		11110	Set as Pack 31
31		11111	Set as Pack 32

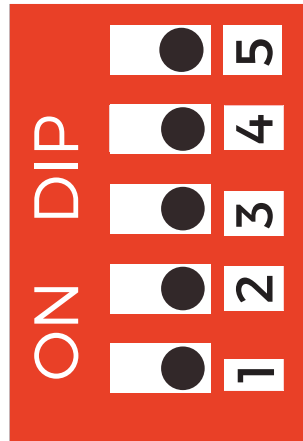



First, locate the PROT port on the operation panel. When the inverter is selected, the communication protocol can be set using the rotary switch. Each address operates independently, ensuring precise communication and system integrity.

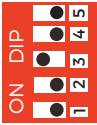
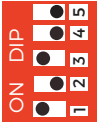
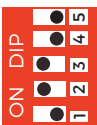
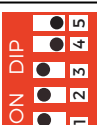
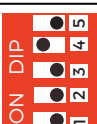
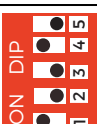
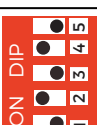
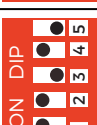
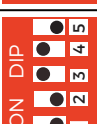

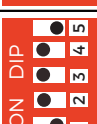
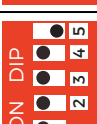

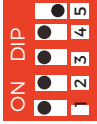
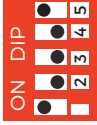
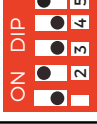

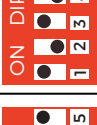
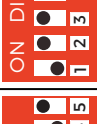
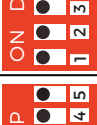
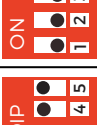
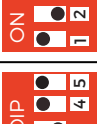
PROT

Address	Location of Dial Switch	Inverter communication protocol
0	ON DIP ● ● ● ● ● 1 2 3 4 5	00000 Soluna Energy_Default (SolarMax. Solis.Goodwe.Solax.SAJ.Sinexcel. AUXSOI.Chisage)
1	ON DIP ● ● ● ● ● 1 2 3 4 5	00001 Soluna (Deye.Afore.Hoymiles. APstorage.Anicsun IP65. Hypontech)
2	ON DIP ● ● ● ● ● 1 2 3 4 5	00010 SMA
3	ON DIP ● ● ● ● ● 1 2 3 4 5	00011 Voltronic.Anicsun IP21

4		00100	Must
5		00101	Phocos Any-Grid
6		00110	Victron
7		00111	Growatt
8		01000	Luxpower
9		01001	Megarevo
10		01010	Aiswei
11		01011	/
12		01100	/
13		01101	/
14		01110	/
15		01111	No communication mode









16		10000	/
17		10001	/
18		10010	/
19		10011	/
20		10100	/
21		10101	/
22		10110	/
23		10111	/
24		11000	/
25		11001	/
26		11010	/

27		11011	/
28		11100	/
29		11101	/
30		11110	/
31		11111	/

11 Installation

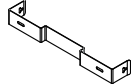
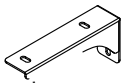
11.1 Packing Lists

Here is the list of items included in the package, along with their quantities. If any item is damaged or missing, please contact Soluna or your distributor:

Item	Name	Describe	Qty (pcs)	Photo
1	Soluna Bes 5K Pack	The main LiFePO4 lithium battery unit.	1	
2	Expansion Bolt M6*60	Expansion Bolt M680*: Used for securely mounting the battery pack to the wall.	6	
3	Screws-M4*10	Screws-M4*: Smaller screws for various assembly points.	2	
4	Communication Cable	Facilitates CAN/RS485 communication between the battery and other systems.	1	
5	Wall Support	Provides additional support for wall-mounted installations.	1	
6	Wall Bracket	Used to mount the battery pack securely on the wall.	2	
7	M5*10	Medium-sized screws for securing components in place.	6	
8	Positioning Plate	Ensures the battery pack is positioned correctly during installation.	1	
9	Bakelite handle	/	1	

11.2 Installation Materials

These installation materials shall be prepared by installers.

- Charging cables
- Communication cable.

11.3 Installation Location

If that isn't feasible, please ensure the installation location meets the following conditions:

- The building is designed to withstand earthquakes.
- The location is far away from the sea to avoid exposure to saltwater and humidity.
- The floor is flat and level.
- There are no flammable or explosive materials nearby.
- The ambient temperature is between 15 and 30°C.
- The temperature and humidity remain constant.
- There is minimal dust and dirt in the area.
- There are no corrosive gases present, including ammonia and acid vapor.
- The battery system should not be placed in direct sunlight; it is suggested to build sunshade equipment.
- In cold areas, a heating system is required.



If the ambient temperature falls outside the optimal range, the battery pack will automatically stop operating to protect itself. The best temperature range for the battery pack to function is between 15°C and 30°C. Frequent exposure to extreme temperatures can degrade the performance and shorten the lifespan of the battery pack.

11.4 Installation Tools Requirements

The following tools are required to install the battery pack:

Remark:

Use properly insulated tools to prevent accidental electric shock or short circuits.

Item	Photo	Name
1		Phillips-screwdriver bit
2		Wire cutters
3		Wire stripper
4		Tape measure
5		Pistol drill
6		Spirit level
7		Electrical insulating tape
8		Multimeter
9		Marker pen

When handling the battery pack, it is essential to wear the appropriate safety gear to protect against potential hazards, installers must adhere to the relevant requirements of international standards, such as IEC 60364, or comply with domestic legislation.

1		Safety goggles
2		Safety shoes
3		Insulated gloves

11.5 Wiring Specification

To standardize the wiring specifications for the Soluna Bes 5K Pack, the following requirements must be met for connecting wires:

Battery Wire	Communication Cable
It is recommended to use 20 mm ² (4AWG) of conductor with double insulation.	It is recommended to use Standard communication cable with shielding function.

11.6 Battery Units Parallel Communication Connection

To standardize the wiring specifications for the Soluna Bes 5K Pack, the following requirements must be met for connecting wires:

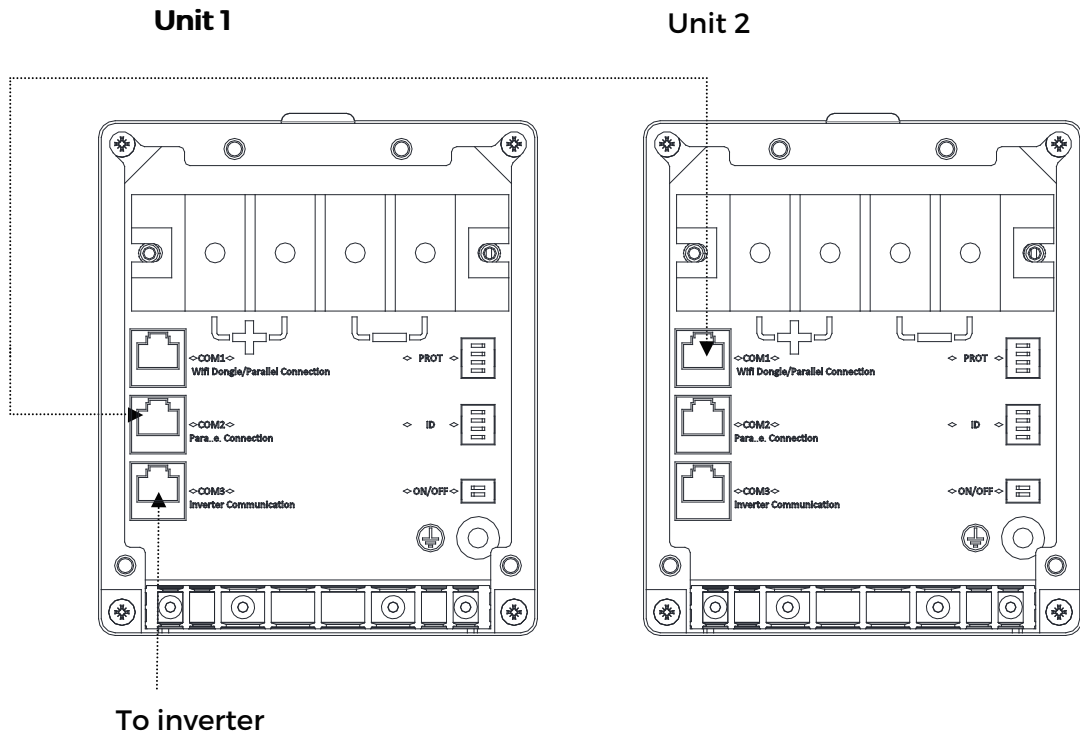

Remark:

- 1) COM 1 Wifi Dongle/Parallel Connection
- 2) COM 2 Parallel Connection
- 3) COM 3 Inverter Communication
- 4) Please find the above drawings for details.

11.7 Standalone

Please select the protocol on the inverter first. Be sure to choose the correct protocol based on the inverter model and its manual.

Diagram: Please refer to the following diagram for detailed visual instructions.

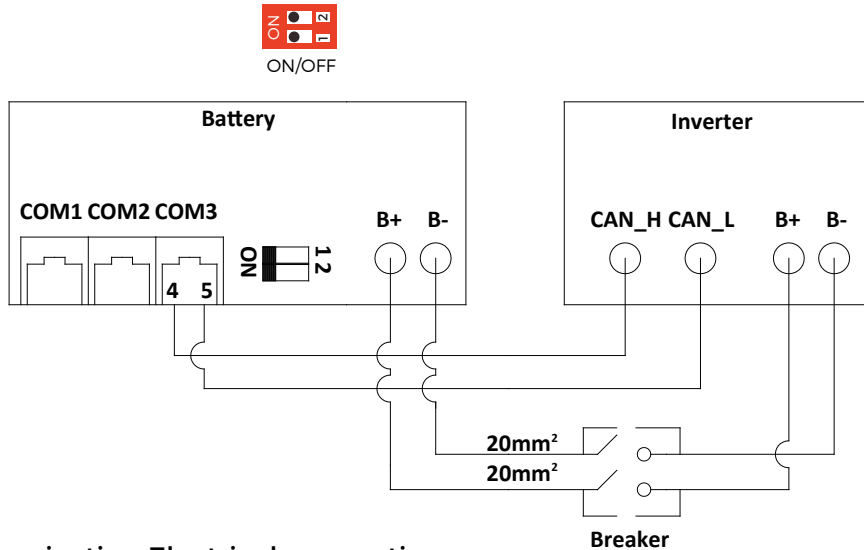

● CAN Communication Electrical connection

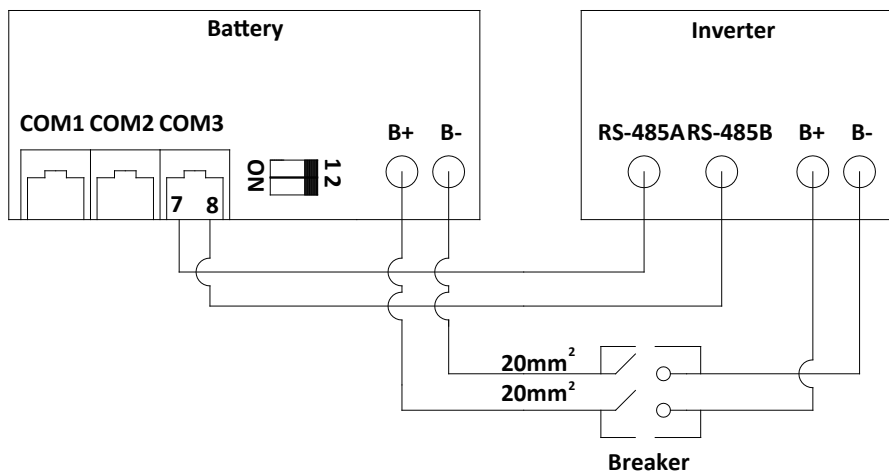

● RS485 Communication Electrical connection

Remark:

During CAN communication

- When using the CAN interface to communicate with the inverter, either or both of the Dip Resistance 1 & 2 should be in the “ON” position.
- After connecting the battery to the inverter, first engage the circuit breaker, and then turn on the battery.

11.8 Multiple Clusters

Diagram: Please refer to the following diagram for detailed visual instructions.

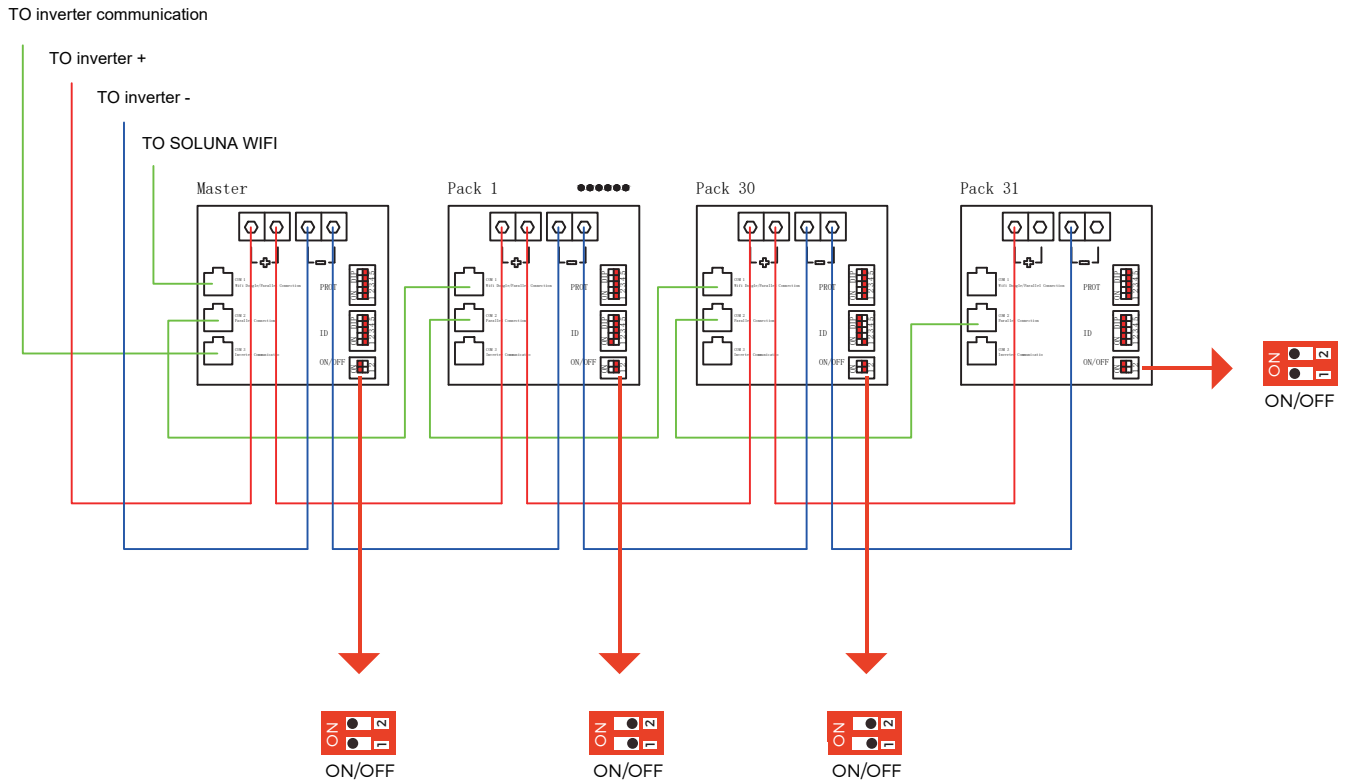

● RS485 Communication Electrical connection

Remark:

During CAN communication

- Dial the code only for the first battery and the last battery, either or both of the Dip Resistance 1 & 2 should be in the "ON" position.
- After connecting the battery to the inverter, first engage the circuit breaker, and then turn on the battery.

11.9 Installation Method

Wall Mounting

- Take the product out and install the carrying handle.
- Place the positioning cardboard against the wall and mark the openings for drilling.
- Drill holes at the marked positions using an impact drill, with a hole size of 10mm
- Use 6 expansion screws to attach the wall-mount bracket and hanging bracket to the wall.
- Place the product onto the wall-mount bracket.
- Use 6 PCS M5 screws to secure the product onto the bracket.
- Remove the carrying handle.
- Secure the product in place, then install the wiring harness.

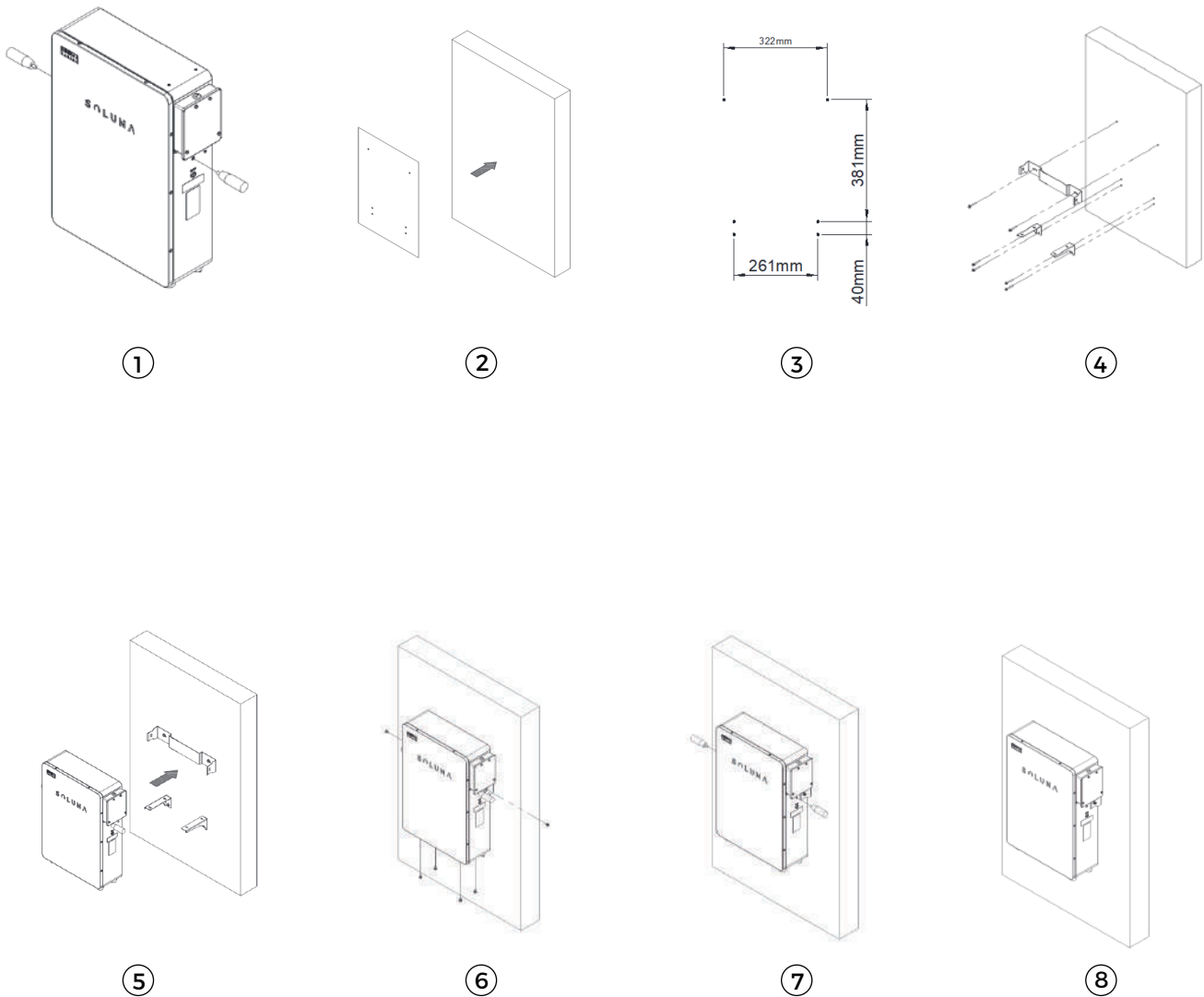

11.9 Installation Method

Floor Mounting

- Take the product out and install the carrying handle.
- Drill holes using an impact drill according to the specified dimensions, with a hole size of 10mm
- Use 2 expansion screws to attach the wall-mount bracket to the wall.
- Place the product into the wall-mount bracket.
- Use 2 PCS M5 screws to secure the product onto the bracket.
- Remove the carrying handle.
- Secure the product in place, then install the wiring harness.

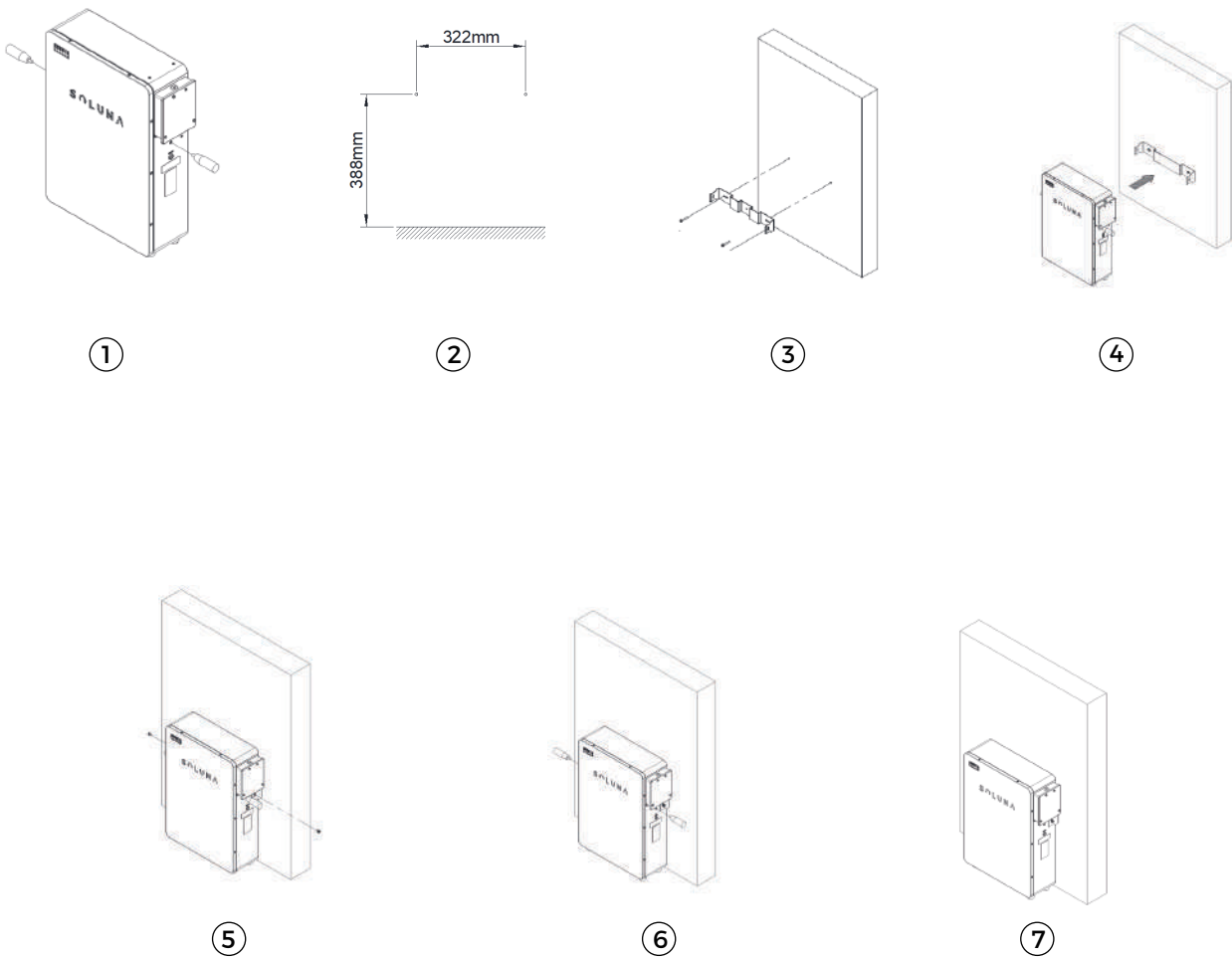

11.9 Installation Method

To start the Soluna Bes 5K Pack, follow these steps:

- **Press the ON/OFF Button**

The Soluna Bes 5K Pack will start operating within 15 seconds.

- **Note on Communication**

The Soluna Bes 5K Pack will cease output if there is no communication between the battery and the inverter within 10 minutes.

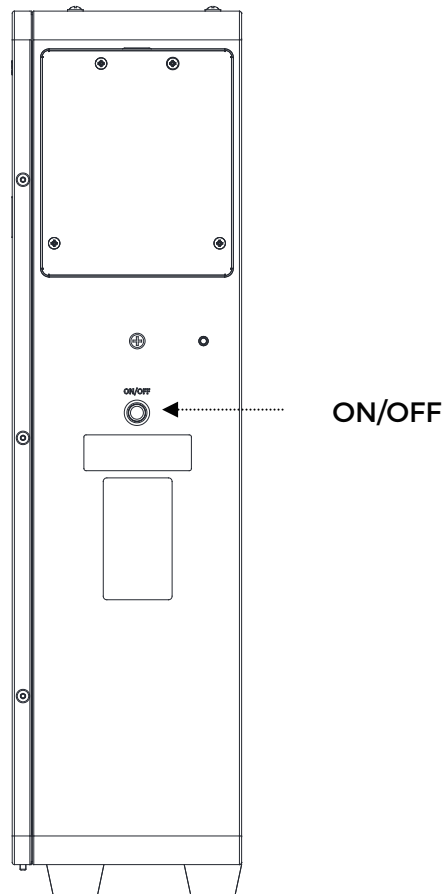

12 No communication mode setting parameters

12.1 Battery parameter settings on the inverter

Max Charging(Bulk) Voltage	55.6V
Absorption Voltage	55.2V
Float Voltage	54.4V
Shut Down(cut off) Voltage	49.4V
Shut Down(cut off) SOC	25%
Max Charge Current	50A*battery QTY
Max Discharge Current	50A*battery QTY

13 Trouble Shooting Guideline

Please find the following table for details

Phenomenon	LED Alarm	Cause	Solution
System not working properly	Flashes 1 time every 5 seconds	Battery ID address is duplicated	Check whether the battery ID has duplicate addresses. After modification, please shut down and restart all batteries with duplicate addresses
The system shuts down after running for about 10 minutes	Flashes twice every 5 seconds	Master battery protocol and inverter protocol are not compatible	Check the master battery protocol address, please restart the master after modification
System not working properly	Flashes 3 times every 5 seconds	Hardware Fault	Immediately turn off the battery and contact after-sales personnel
When the number of batteries is more than 2, the battery will stop charging and discharging intermittently	Flashes 4 times every 5 seconds	The voltage difference between the batteries is more than 1.5V	The battery is charged and discharged normally. When the voltage difference between the batteries is less than 1.5V, Once the wiring connections are correctly made, the battery pack will automatically be paralleled successfully. At the moment of paralleling, the battery will stop charging and discharging intermittently and then resume work. This is a normal phenomenon
The system shuts down after running for about 10 minutes	Flashes 5 times every 5 seconds	The communication between the master and the inverter is interrupted	1.Check whether the protocol dial position of the master battery corresponds to the inverter protocol 2.Check whether the communication cable between the master battery and the inverter is correct. Ensure that the communication interface is plugged in correctly and inserted firmly.

13 Trouble Shooting Guideline

The master is running normally, and the battery of the slave is turned off	Flashes 6 times every 5 seconds	No communication between master and slave	Check whether the communication cable between the master battery and the inverter is correct. Ensure that the communication interface is plugged in correctly and inserted firmly.
System not working properly	Flashes 7 times every 5 seconds	There is a problem with the charging MOSFET	Stop all charging and discharging activities, turn off the battery, and contact after-sales personnel immediately. Do not touch the positive and negative poles of the battery, and ensure that only qualified professionals handle the final steps.
System not working properly	Flashes 8 times every 5 seconds	There is a problem with the discharging MOSFET	Stop all charging and discharging activities, turn off the battery, and contact after-sales personnel immediately. Do not touch the positive and negative poles of the battery, and ensure that only qualified professionals handle the final steps.
The battery cannot be charged or discharged	Flashes 9 times every 5 seconds	The battery temperature detection harness is damaged	Please contact the after sales personnel and let the after sales personnel handle it
System not working properly	Alarm LED always on and SOC is lower than 25%	The battery triggers the mandatory protection state	1. Power off and restart the battery for charging 2. Contact the after sales personnel
No output after battery power on		1.The master address is wrong 2.MOSFET open 3.FUSE burnt	Check if the master address is set to 0. Verify the positive and negative wiring of the battery for correctness. Inspect the monitoring software for any protection alerts. Measure the voltage of the positive and negative poles of the battery. If the voltage is lower than 44.8V, contact the after-sales personnel for assistance.
The battery cannot be charged or discharged	LED always on	Trigger over temperature/under temperature/temperature difference/alarm and protection	Please contact after sales personnel

13 Trouble Shooting Guideline

Notice

Damage to the Battery System Due to Under Voltages

- **Timely Charging**

Charge the over-discharged system within seven days when the temperature is above 25°C.
Charge the over-discharged system within fifteen days when the temperature is below 25°C.

- **Contact for Assistance**

If the battery system doesn't start up, please contact Soluna local after-sales service within 48 hours. Otherwise, the battery could be permanently damaged.

14 Depth of Discharge (DoD) setting of inverter

To make sure the battery working smoothly, we recommend the DOD setting of inverter as follows.

On-Grid DOD:90%

Off-Grid DOD:70%

Power dispatching mode DoD:70%

15 Register on the Website after Installation

After completing the installation of the battery system and confirming that it is operating normally, please log in to the Soluna official website to register your product installation and usage details. This registration is required for the product warranty to take effect. Follow the on-screen instructions on the website to complete the registration process.

<https://soluna.co> → SUPPORT & SERVICE → Warranty registration

If you have any questions, feedback, or need assistance, please feel free to reach out to us. We are here to help!

Soluna (Shanghai) Co.,Ltd

Add: No.3492 Jinqian Road, Shanghai, China 201406

Tel: +86-21-57475835

Email: sales@solunabattery.com

Web: www.solunabattery.com

Social media: <https://www.linkedin.com/company/solunabattery>