

User Manual
Soluna EVO 5K Pack
A.0

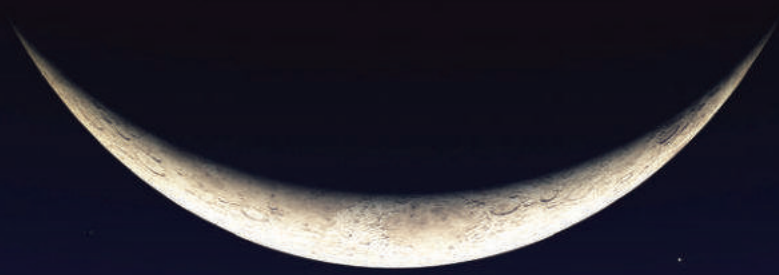

About this Specification

This manual provides comprehensive instructions for installing the Soluna EVO 5K Pack. It is imperative to thoroughly read this manual before attempting to install the product and to follow the instructions diligently throughout the installation process.

If you have any doubts about the requirements, recommendations, or safety procedures described in this manual, please contact Soluna immediately for advice and clarification.

The information contained in this manual is accurate at the time of publication. However, due to ongoing updates to product design and technical specifications, our company reserves the right to make changes at any time without prior notice. Additionally, the illustrations included in this manual are intended to aid in explaining system configuration concepts and installation instructions. The items depicted in the illustrations may differ from the actual items at the installation site.

SOLUNA (SHANGHAI) CO.,LTD reserves the copyright of this document.

1. Introduction.....	04
2. Features.....	05
3. Safety Precautions.....	06
3.1 Warning Signs	07
3.2 Safety Instructions	07
3.3 Battery Handling Guide	08
3.4 Response to Emergency Situations	08
3.5 Qualified Installers	10
4. Appearance.....	11
5. Technical Specifications.....	13
6. COM Communication Interface Definition.....	16
7. Battery ID Setting.....	17
8. PROT Setting(Communication Protocol Setting).....	21
9. Installation.....	25
9.1 Packing list.....	25
9.2 Installation Materials.....	25
9.3 Installation Location.....	25
9.4 Installation Tools.....	26
9.5 Safety Gear.....	27
9.6 Wiring Specification.....	27
9.7 Installation method.....	28
9.8. Electrical connection.....	29
10. Operation.....	32
10.1. Check Before Power ON	32
10.2. Power On.....	32
10.3. Indicator light.....	32
11. No communication mode setting parameters	34
12. Troubleshooting Guidelines	35
13. Depth of Discharge (DOD) Setting of Inverter.....	38
14. Register on the Website after Installation	39
15. Contact us	40

Introduction

The Soluna EVO 5K Pack is a cutting-edge LiFePO₄ lithium battery solution, equipped with an advanced Battery Management System (BMS). This sophisticated battery module features CAN and RS485 communication capabilities, providing comprehensive protection against under-voltage, over-voltage, over-current, over-temperature, and under-temperature scenarios.

Key attributes of the Soluna EVO 5K Pack include:

- **High Energy Density**

Maximizes power storage within a compact footprint.

- **Extended Lifespan**

Offers long-lasting performance, ensuring reliability over extensive use.

- **Robust Safety Features**

Incorporates multiple layers of safety mechanisms to prevent damage and ensure safe operation. The superior safety performance minimizes risks.

- **EMS scheduling function**

Achieve a total capacity of up to 0.8MWh, which can be flexibly applied to installation project needs under various scenarios and requirements. The expandable battery units provide the flexibility to increase the number of battery units as needed.

- **Flexible selection of inverter model**

Adjust the dial on the battery and select or change different inverter protocols easily.

This battery pack exemplifies a dependable and environmentally friendly energy solution, perfectly aligning with green energy initiatives.













Features

- **Extended Cycle Life**
Offers longevity and reliable performance over numerous charge and discharge cycles.
- **CAN/RS485 Communication Support**
Facilitates seamless integration and communication within systems.
- **Parallel Interconnection Capability**
Allows for the connection of multiple systems in parallel, enhancing scalability.
- **Low-Temperature Operation**
Capable of efficient performance in low-temperature environments. The battery is equipped with self-heating function to meet your energy needs in special climate conditions (No heating function by default)
- **Wireless Monitoring**
Enables real-time, remote monitoring for optimal management and oversight.
- **Automatic Output Release Mechanism**
The system has a built-in trip device. If the battery gets out of control, the battery output will be disconnected to ensure life safety. In addition, the battery will be disconnected when it is under voltage and enter a more gentle working mode.
- **Comprehensive Protection Features**
Includes over-temperature, over-current, over-discharge, over-charge, and short-circuit protections to safeguard against operational hazards.

3 Safety Precautions

3.1 Warning Signs

Warning signs are essential indicators designed to alert you to conditions that could result in severe injury or significant damage to the device. They serve as critical reminders to exercise caution and take necessary precautions to prevent hazardous situations. The table below outlines the warning signs used in this manual and their meanings:

Sign	Description
	High Voltage Warning: This battery pack operates at high voltage, which can cause severe injury due to electric shock.
	Correct Polarity: Ensure the battery polarity is correctly connected.
	Fire Safety: Keep the battery pack away from open flames or ignition sources.
	Child Safety: Store the battery pack out of reach of children.
	Installation Manual: Thoroughly read the manual before installing and operating the battery pack.
	Heavy Weight Warning: The battery pack is heavy, and improper handling may result in severe injury. Utilize proper lifting techniques.
	Electrolyte Leakage: The battery pack may leak corrosive electrolyte. Handle with care and adhere to appropriate safety procedures.
	Explosion Risk: The battery pack may explode under certain conditions.
	Disposal Instructions: Do not dispose of the battery pack with household waste at the end of its working life. Follow local regulations for disposal.
	Compliance Requirement: Failure to follow the provided requirements and guidelines may lead to physical injury or damage to the device.
	Do not short circuit.
	Grounding conductor This symbol indicates the position for connecting a grounding conductor.

3.2 Safety Instructions

For safety reasons, it is crucial that installers thoroughly familiarize themselves with the contents of this manual and all associated warnings prior to commencing the installation.



General Safety Precautions

Failure to adhere to the precautions outlined in this section can result in serious injury or property damage. Please observe the following safety guidelines:

3.2.1 Risks of Explosion

- Avoid subjecting the battery pack to strong impacts.
- Do not crush or puncture the battery pack.
- Never dispose of the battery pack in a fire.

3.2.2 Risks of Fire

- Do not expose the battery pack to temperatures exceeding 60°C.
- Keep the battery pack away from heat sources, such as fireplaces.
- Avoid exposing the battery pack to direct sunlight.
- Ensure the battery connectors do not come into contact with conductive objects like wires.

3.2.3 Risks of Electric Shock

- Refrain from disassembling the battery pack.
- Do not touch the battery pack with wet hands.
- Keep the battery pack away from moisture or liquids
- Ensure the battery pack is kept away from children and animals.

3.2.4 Risks of Damage to the Battery Pack

- Prevent the battery pack from coming into contact with any liquids.
- Avoid subjecting the battery pack to high pressures.
- Do not place any objects on top of the battery pack

3.3 Battery Handling Guide

- Use the battery pack strictly as directed in the manual.
- Do not use the battery pack if it appears defective, cracked, broken, or fails to operate correctly.
- Do not attempt to open, disassemble, repair, tamper with, or modify the battery pack as it is not user serviceable.
- Handle the battery pack with care during transportation to avoid damage.
- Avoid impacting, pulling, dragging, or stepping on the battery pack.

3.4 Response to Emergency Situations

The Soluna EVO 5K Pack consists of multiple batteries designed to prevent hazards resulting from failures. However, Soluna cannot guarantee absolute safety. Please familiarize yourself with the following emergency procedure.

3.4.1 Leaking Batteries

If the battery pack leaks electrolyte, avoid contact with the leaking liquid or gas. Electrolyte is corrosive and contact may cause skin irritation and chemical burns. If exposed to the leaked substance, follow these steps:

3.4.2 Inhalation

- Evacuate the contaminated area immediately.
- Seek medical attention without delay.

3.4.3 Eye Contact

- Rinse eyes with flowing water for at least 15 minutes.
- Seek medical attention immediately.

3.4.4 Skin Contact

- Wash the affected area thoroughly with soap and water.
- Seek medical attention immediately.

3.4.5 Ingestion

- Induce vomiting.
- Seek medical attention immediately.

3.4.6 Fire Response Procedures

In the event of a fire, always have an ABC or carbon dioxide extinguisher on hand.



The battery pack may ignite if heated above 15 °C. If a fire occurs where the battery pack is installed, follow these steps:

- **Extinguish Early**

Attempt to extinguish the fire before the battery pack ignites.

- **Safe Relocation**

If extinguishing is not possible but time allows, move the battery pack to a safe area before it catches fire.

- **Evacuate**

If the battery pack has already caught fire, do not attempt to extinguish it. Evacuate the area immediately.



Caution: If the battery catches fire, it will emit noxious and poisonous gases. Do not approach the fire.

3.4.7 Wet Batteries

If the battery pack becomes wet or submerged in water, do not attempt to access it. Contact Soluna or your distributor for technical assistance immediately.

3.4.8 Damaged Batteries

Damaged batteries are hazardous and must be handled with extreme caution. They are unfit for use and may pose a danger to people or property.

If the battery pack appears damaged, pack it in its original container and return it to Soluna or your distributor.



Leakage and Flammability: Damaged batteries may leak electrolyte or produce flammable gas. If you suspect such damage, contact Soluna for advice and information immediately.

3.5 Qualified Installers

This manual, along with the tasks and procedures described herein, is intended for use by skilled professionals only. A skilled professional is defined as a trained and qualified electrician or installer who possesses all of the following skills and experience:

- **Functional Knowledge**

Understanding of the principles and operation of on-grid systems.

- **Risk Awareness**

Awareness of the dangers and risks associated with installing and using electrical devices and the acceptable methods for mitigating these risks.

- **Installation Proficiency**

Expertise in the installation of electrical devices.

- **Adherence to Guidelines**

Knowledge of and compliance with this manual, including all safety precautions and best practices.

- **Battery Maintenance**

Only authorized personnel should perform maintenance. Turn off the battery before maintenance. Periodically check voltage, SOC, and cables for damage or wear. Perform balancing maintenance (fully charge) every three months.

- **Installation Environment Requirements**

Avoid flammable, explosive, or corrosive materials. Keep out of children's reach and avoid high temperatures. Ensure proper ventilation and avoid electromagnetic interference. Install in a sheltered, well-ventilated area, within the appropriate temperature and humidity range, and below 2000 meters altitude.

4 Appearance

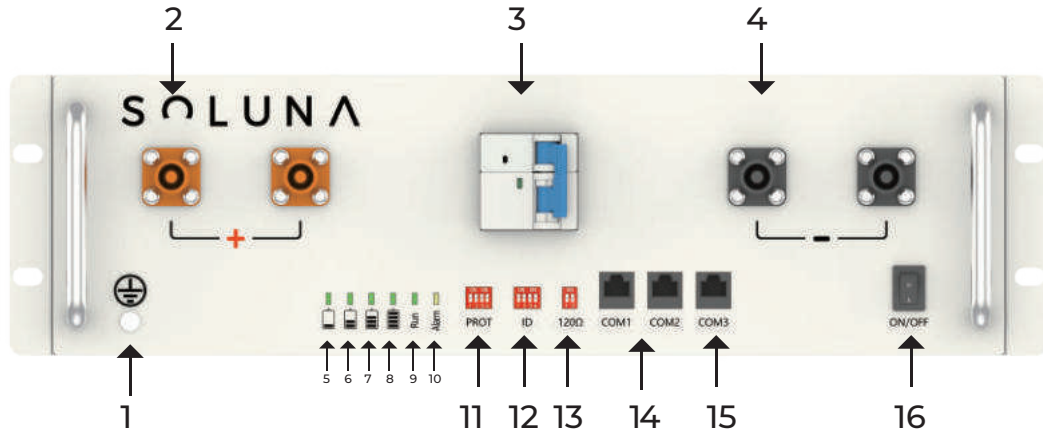

Number	Name	Description
1	Earthing	Connection for earth wire
2	Positive Power Terminal	Positive input and output interface
3	Battery output breaker	With automatic release device
4	Negative Power Terminal	Negative input and output interface
5	25% capacity indicator	Green light
6	50% capacity indicator	Green light
7	70% capacity indicator	Green light
8	100% capacity indicator	Green light
9	Running indicator light	The green light flashes when charging, and stays on when discharging
10	Alarm indicator light	The yellow light flashes when alarming.

11	PORT	Use for battery communication protocol set
12	ID	Use for battery ID set
13	120Ω	Communication terminal resistance
14	COM1/COM2	RJ45 interface for the RS485 protocol, enabling seamless parallel communication. This allows for efficient real-time monitoring and remote upgrades. It is particularly beneficial for managing multiple battery installations, ensuring optimal performance and reliability across all connected units.
15	COM 3	RJ45 port, follows CAN protocol, also facilitates direct communication between the battery and the inverter, ensuring transmission of battery information to the inverter.
16	ON/OFF	BMS power switch

4.1 Battery Maintenance

Danger: Only professional and authorized personnel are permitted to perform battery maintenance.

Danger: Ensure the battery is turned off before performing any maintenance tasks.

4.2 Voltage Inspection

[Periodical Maintenance] Check the battery voltage using the monitoring software. Verify that the system voltage is within the normal range. For example, check if the voltage of individual cells is within the rated range.

4.3 SOC Inspection

[Periodical Maintenance] Check the State of Charge (SOC) of the battery using the monitoring software. Ensure that the SOC of the battery string is within the normal range.

4.4 Cables Inspection

[Periodical Maintenance] Visually inspect all battery cables. Check for any signs of damage, aging, or looseness.

4.3.4 Balancing

[Periodical Maintenance] If the battery has not been fully charged for a long time, it may become unbalanced. To correct this, perform balancing maintenance by fully charging the battery every three months. Ensure that this maintenance is done when external devices, such as the monitoring software and battery inverter, are properly communicating.

5 Technical Specifications

Battery type	LFP
Dimension(W*D*H)	442*498* 130.5(mm)
Weight	Approx.42 kg ⁽¹⁾
Total Energy Capacity	5.12 kWh
Usable Energy Capacity	4.096 kWh
Battery Capacity (Nominal)	100 Ah
Voltage Range(Usable)	44.8~56.8 V
Nominal Voltage	51.2 V
Nominal Charge Voltage	56.8 V
Charge/Discharge Current (Nominal)	50 A
Charge/Discharge Current (Max)	75 / 100 A
Max.Charging/Discharging	5120 W
Round-Trip Efficiency	≥94%
DOD	80% ⁽²⁾

- (1) Warning: Each battery module weighs 46kg. If lifting equipment is not available, ensure that at least two people are present to install the battery module. For installations at higher positions, a minimum of three people is required.
- (2) Test Conditions: 10 0% Depth of Discharge (DOD), 0.2 °C charge and discharge at +25±2 °C for the battery at the beginning of its life. Usable energy may vary with different inverters.

Cycle life (@25℃,0.5C,80%DOD, 70%EOL)	8000 Cycles ⁽³⁾
Protection & Alarm	Over temperature, Over current ,Short circuit, Over discharge ,Over charge, etc
Max.quantity of parallel connection	32 (If it is used with Soluna Smart -EMS, the max.quantity of parallel batteries will be expanded to 160units)
Communication	CAN、RS-485
Self discharge @25℃	≤3% ⁽⁴⁾
Condition	Indoor conditioned
Operating Temperature	Charge: 0~50℃,Discharge:-10~50℃
Operating Temperature (Recommended)	15~30℃ ⁽⁵⁾
Storage Temperature	-20~60℃
Humidity	5%~95% RH
Altitude	Max. 2,000
Cooling Strategy	Natural Convection
Certificates	IEC62619,IEC62477,UL1973, UL9540A EMC,FCC,ROHS
Transportation	UN38.3
Ingress Rating	IP20
Warranty	Please refer to SOLUNA WARRANTY CONDITIONS

(3) Note: At 25±2℃ of cell under 0.5C/0.5C test condition and 70% End of Life (EOL).

(4) Note: Nominal discharge/charge current and power derating will occur depending on temperature and State of Charge (SOC).

(5) For long-term storage: Store battery cells in a temperature range of 5~45℃, with relative humidity below 65%, and in a non-corrosive environment. Charge to 50-55% SOC before storage to prevent significant cycle life reduction.

NOTE

- When a level 1 alarm is triggered, the charge or discharge rate will be reduced.
- When a level 2 alarm is triggered, charge and discharge operations will be limited to OA.
- Prolonged discharging at currents below 0.5A may lead to inaccuracies in the State of Charge (SOC) calculation.
- Storage SOC: Maintain a State of Charge (SOC) between 30% and 50% for storage, and cycle the charge-discharge process every 6 months.
- Store the battery at a temperature range of 15~30 °C, for periods not exceeding one year.

6 COM Communication Interface Definition

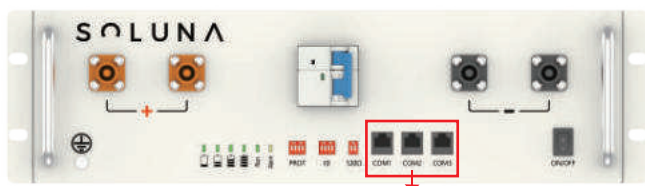

CAN1-8

COM 1:

1	2	3	4	5	6	7	8
RS-485A (WIFI)	RS-485B (WIFI)	12 V	CAN-H	CAN-L	GND	RS-485A	RS-485B

COM 2:

1	2	3	4	5	6	7	8
RS-485A (WIFI)	RS-485B (WIFI)	12 V	CAN-H	CAN-L	GND	RS-485A	RS-485B

COM 3:

1	2	3	4	5	6	7	8
NC	NC	NC	CAN-H	CAN-L	NC	RS-485A	RS-485B

Remark:

- COM 1(Communication terminal resistance) is used for BMS monitoring.
- COM 2 (Communication terminal resistance) is used for BMS monitoring.
- COM 3(RJ45 port, follows CAN protocol, for outputting battery information.) is used for inverter communication.

7 Battery ID Setting



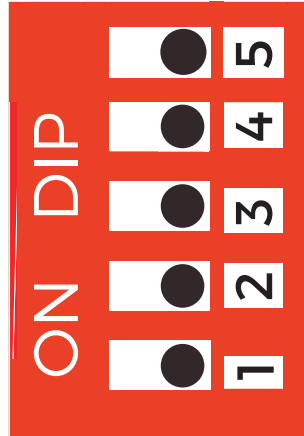

When the battery modules are connected in parallel, the address of each battery module can be configured using the dial switch. Each address is unique and independent, ensuring proper identification and communication among the connected modules.





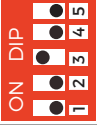
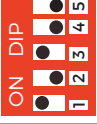
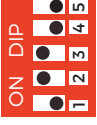
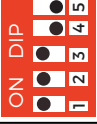
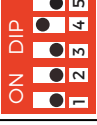
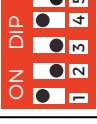
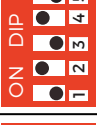

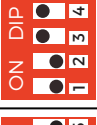
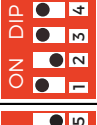

ID

Address	Location of Dial Switch		
0		00000	Master 1
1		00001	Set as Pack 2
2		00010	Set as Pack 3
3		00011	Set as Pack 4

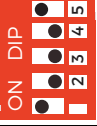
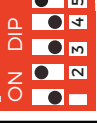

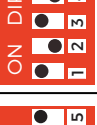

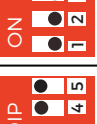
7 Battery ID Setting

4		00100	Set as Pack 5
5		00101	Set as Pack 6
6		00110	Set as Pack 7
7		00111	Set as Pack 8
8		01000	Set as Pack 9
9		01001	Set as Pack 10
10		01010	Set as Pack 11
11		01011	Set as Pack 12
12		01100	Set as Pack 13
13		01101	Set as Pack 14
14		01110	Set as Pack 15
15		01111	Set as Pack 16

7 Battery ID Setting

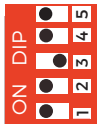
16		10000	Set as Pack 17
17		10001	Set as Pack 18
18		10010	Set as Pack 19
19		10011	Set as Pack 20
20		10100	Set as Pack 21
21		10101	Set as Pack 22
22		10110	Set as Pack 23
23		10111	Set as Pack 24
24		11000	Set as Pack 25
25		11001	Set as Pack 26
26		11010	Set as Pack 27

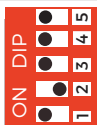
7 Battery ID Setting

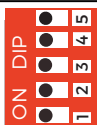

27		11011	Set as Pack 28
28		11100	Set as Pack 29
29		11101	Set as Pack 30
30		11110	Set as Pack 31
31		11111	Set as Pack 32

8 PROT Setting(Communication Protocol Setting)

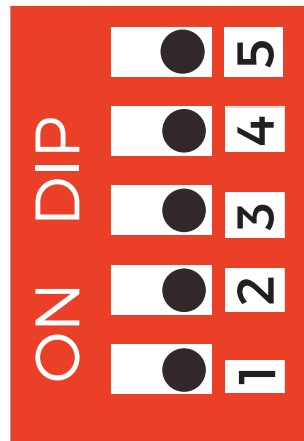



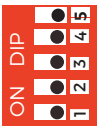
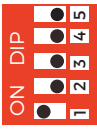

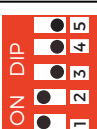

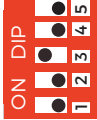

Users can set the battery communication protocol according to the inverter model, Please refer to the table below for detailed information:





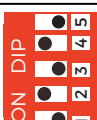
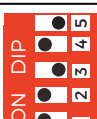
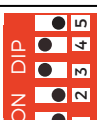

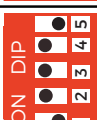



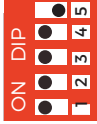

PROT

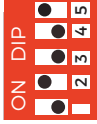
Address	Location of Dial Switch	Inverter communication protocol
0	 00000	Soluna Energy_Default (SolarMax. Solis.Goodwe.Solax.SAJ.Sinexcel. AUXSOI.Chisage)
1	 00001	Soluna (Deye.Afore.Hoymiles. APstorage.Anicsun IP65. Hypontech)
2	 00010	SMA
3	 00011	Voltronic.Anicsun IP21

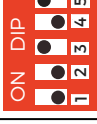
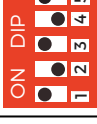
8 PROT Setting(Communication Protocol Setting)

4		00100	Must
5		00101	Phocos Any-Grid
6		00110	Victron
7		00111	Growatt
8		01000	Luxpower
9		01001	Megarevo
10		01010	Aiswei
11		01011	/
12		01100	/
13		01101	/
14		01110	/
15		01111	No communication mode

8 PROT Setting(Communication Protocol Setting)

16		10000	/
17		10001	/
18		10010	/
19		10011	/
20		10100	/
21		10101	/
22		10110	/
23		10111	/
24		11000	/
25		11001	/
26		11010	/

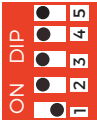
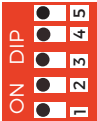

8 PROT Setting(Communication Protocol Setting)

27		11011	/
28		11100	/
29		11101	/
30		11110	/
31		11111	/

9 Installation

9.1 Packing list

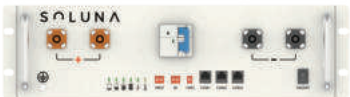
The following table lists the numbers of each item included. If anything is damaged or missing, contact Soluna or your distributor.

Number	Items	Quantity	Specifications
1	Battery	1set	
2	Communication Cable	1pcs	
3	Bolt	4pcs	

9.2 Installation Materials

Installers should prepare the following materials:

- Charging cables.
- communication cable

9.3 Installation Location

Please make sure that the installation location meets the following conditions:

- The building is designed to withstand earthquakes.
- The location is far away from the sea, to avoid salt water and humidity ions.
- The floor is flat and level.
- There are no flammable or explosive materials nearby.
- The ambient temperature is maintained between 15 and 30°C.
- The temperature and humidity are kept constant.
- There is minimal dust and dirt in the area.
- There are no corrosive gases present, including ammonia and acid vapor.

- Do not place the battery system in direct sun light. it is suggested to build sunshade equipment. In cold area the heating system is required.



If the ambient temperature is outside the operating range, the battery pack will cease operation to protect itself. The optimal temperature range for the battery pack to operate is between 15 °C to 30°C. Frequent exposure to extreme temperatures may degrade the performance and longevity of the battery pack.

Battery Module Installation:

Each battery module weighs 46kg. Use at least two people for installation without lifting equipment, and three people for higher positions.



Battery System Safety:

Ensure the battery system is off before connecting to avoid electric shock and inverter damage. Double-check all power and communication cables to ensure the inverter voltage matches the battery voltage.

9.4 Installation Tools

The following tools are required to install the battery pack:

Item	Photo	Name
1		Insulated gloves
2		hydraulic tongs
3		Communication cable crimper
4		Wire cutters

5		Tape measure
6		Multimeter DC voltage

Remark:

Use properly insulated tools to prevent accidental electric shock or short circuits.

9.5 Safety Gear

When handling the battery pack, it is essential to wear the appropriate safety gear to protect against potential hazards. Installers must adhere to the relevant requirements of international standards, such as IEC 60364, or comply with domestic legislation.

Item	Photo	
1		Insulated gloves
2		Safety goggles
3		Safety shoes

9.6 Wiring Specification

To standardize the wiring specifications for the Soluna EVO 5K Pack, the following requirements are mandated for the connecting wires:

Battery Wire	Communication Cable
It is recommended to use 25 mm ² (3AWG) of conductor with double insulation.	It is recommended to use Standard communication cable with shielding function.

- **Data communication cable:**
The cable length and quality affect the quality of the signal. Observe the following cable requirements.
 - Cable category: Cat5, Cat5e or higher
 - Plug type: Metal Shielded RJ45 of Cat5, Cat5e or higher
 - Shielding: Yes
 - UV-resistant for outdoor use
 - Straight-through wired cables Maximum cable length: 10 m.



9.7 Installation method

Standard 3U installation, use 4 PCSI6*12 external hexagonal three-combination screws to fix the product into the cabinet



9.8 Electrical connection

Standalone

-  Communication cable
-  Battery positive pole
-  Battery negative pole

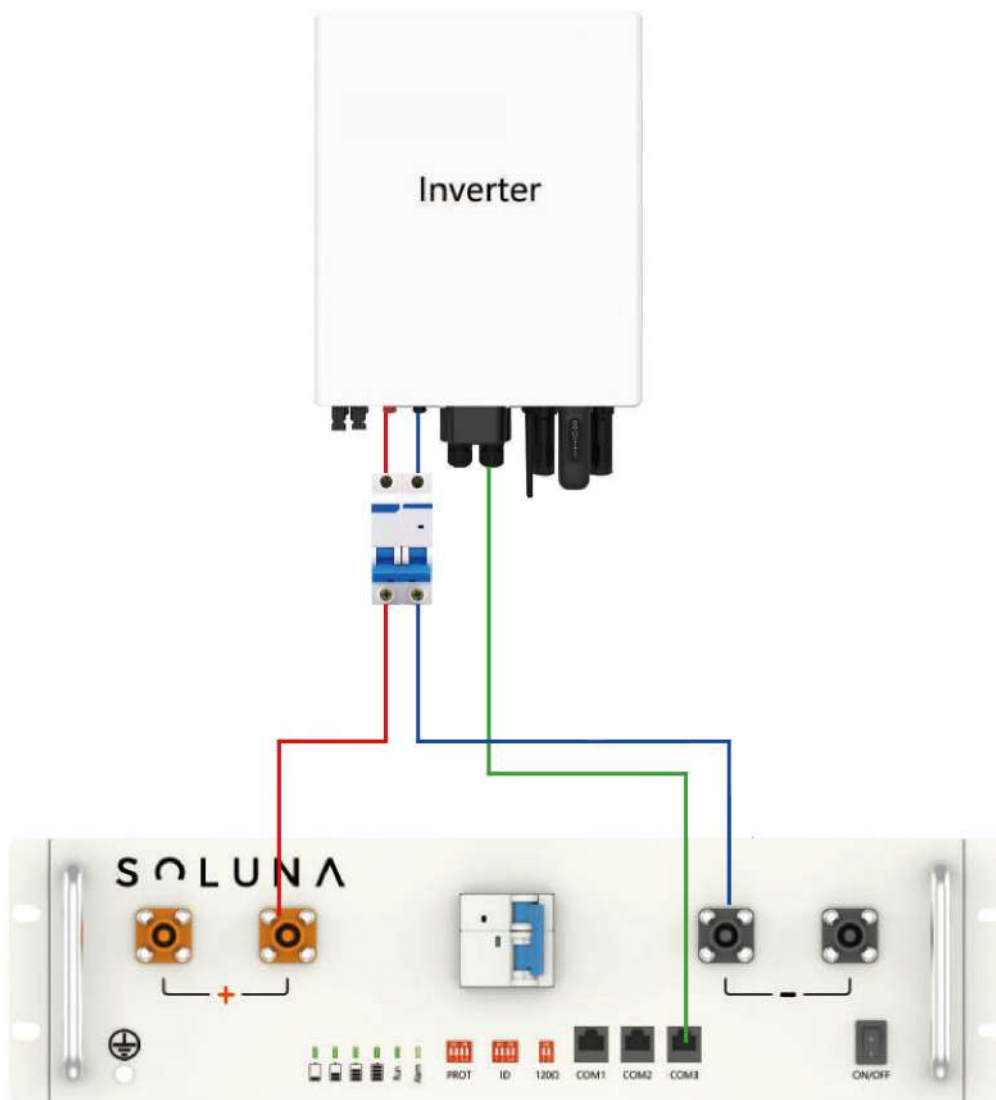

Remark:

When using the CAN interface to communicate with the inverter, either or both of the Dip Resistance 1 & 2 should be in the "ON" position.

Parallel

- Communication cable
- Battery positive pole
- Battery negative pole

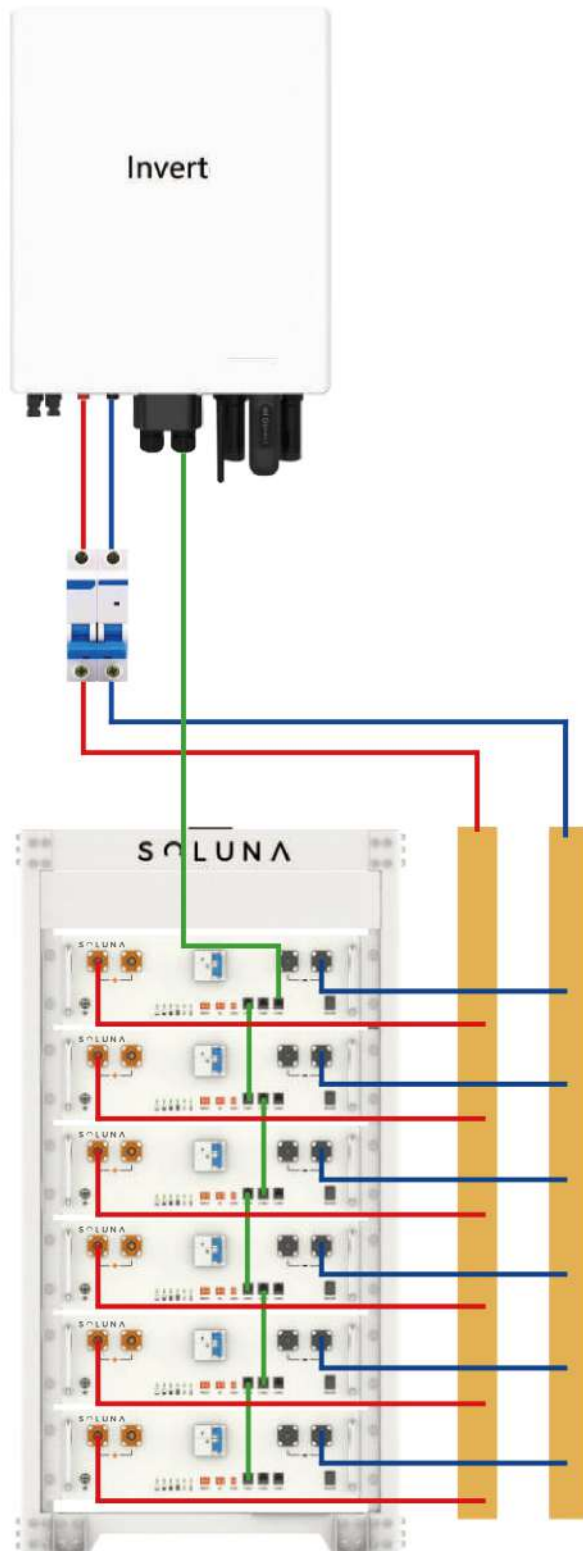

- A single battery pack can be connected in parallel with up to 32 batteries. For specific electrical connections, please refer to section 7, "Battery ID Setting." When setting up a parallel connection, you need to designate one battery as the master and the remaining batteries as slaves. It is recommended to select the first battery at the top as the master to ensure optimal performance and management.



Remark: When using the CAN interface to communicate with the inverter, either or both of the Dip Resistance 1 & 2 on the first & last battery should be in the "ON" position.

Multiple Clusters

- Communication cable
- Battery positive pole
- Battery negative pole
- Ground wire

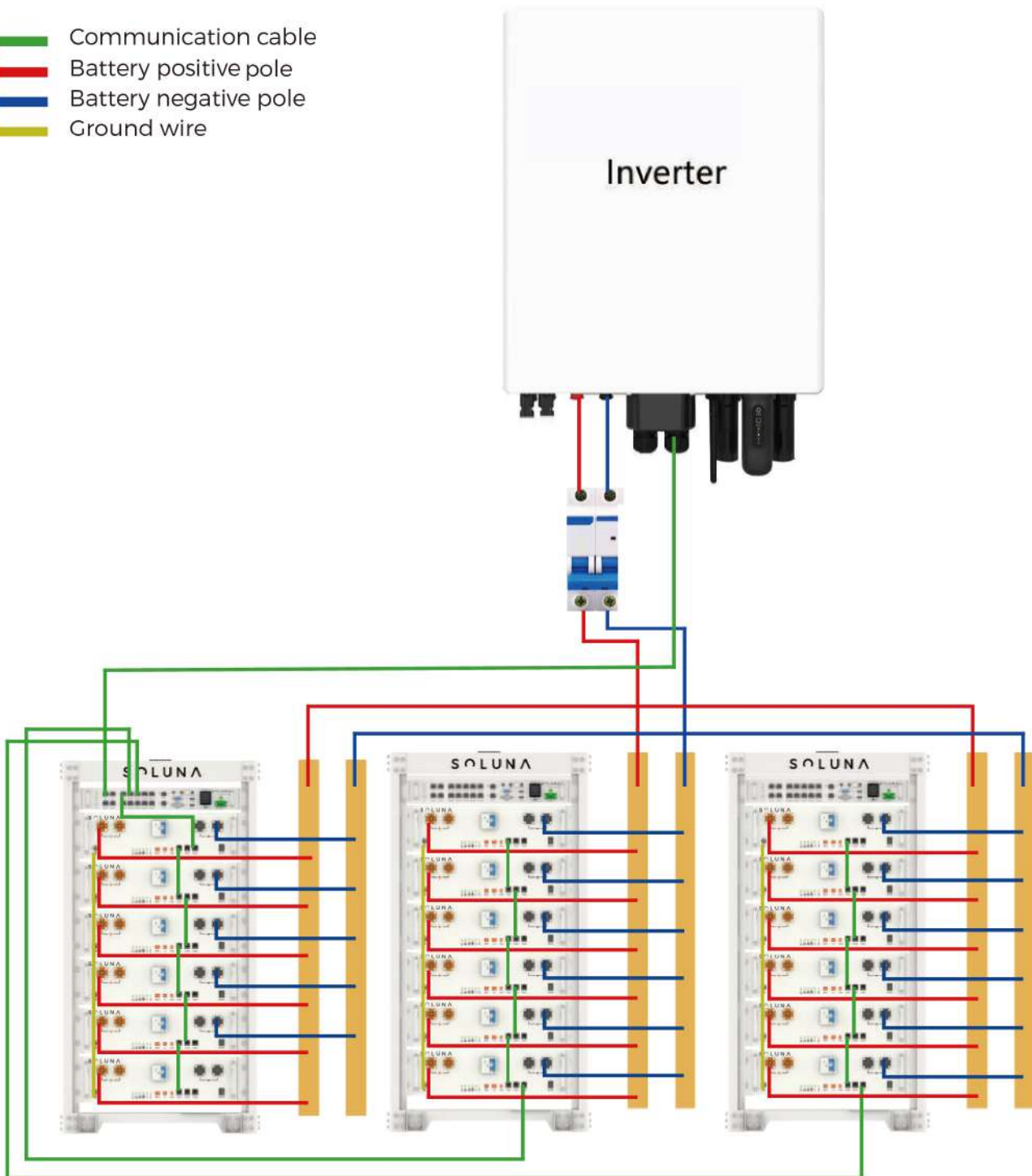

- A single battery pack can be connected in parallel with up to 32 batteries. You can expand this setup to 10 clusters in parallel. For specific electrical connections, please refer to section 7, "Battery ID Setting." When setting up a parallel connection, you need to designate one battery as the master and the remaining batteries as slaves. It is recommended to select the first battery at the top as the master to ensure optimal performance and management.

ON Remark: When using the CAN interface to communicate with the inverter, one or both of the dip resistors (1 and 2) on the first and last batteries of each cluster should be set to the "on" position.

10 operation

10.1 Check Before Power ON

Check the following items before power on to avoid the battery system being damaged.

Note	Check Item
1	The PE cable, power cable, communication cable, and terminal resistor are connected correctly and securely.
2	Cable ties are intact, routed properly and evenly.
3	Unused ports and terminals are sealed.

10.2 Power On

First, select and dial the appropriate code for the specific inverter brand you are installing. Once the on/off switch and breaker are turned on, the system will be operational. When the on/off switch and breaker are turned on.













10.3 Indicator light

SOC indicator

SOC indicator	State	Description
	Steady green	0%<SOC≤25%
		25%<SOC≤50%
		50%<SOC≤75%
		75%<SOC≤100%

Running indicator

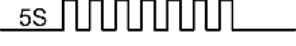
Running indicator	State	Description
 RUN	Steady green	Battery discharging
 Alarm	Flashing green	Battery charging

Fault indicator	Schematic diagram	Description	Fault
 Alarm		Flash once every 5 seconds	ID address duplication
		Flash twice every 5 seconds	Protocol address error Hardware acquisition error
		Flash 3 times every 5 seconds	Hardware acquisition error
		Flash 4 times every 5 seconds	Voltage difference greater than 15V
		Flash 5 times every 5 seconds	Host communication disconnection
		Flash 6 times every 5 seconds	Slave communication disconnection
		Flash 7 times every 5 seconds	Charging MOSFET tube failure
		Flash 8 times every 5 seconds	Discharging MOSFET tube failure
		Flash 9 times every 5 seconds	Temperature line interruption error

11 No communication mode setting parameters

11.1 Battery parameter settings on the inverter

Max Charging(Bulk) Voltage	55.6V
Absorption Voltage	55.2V
Float Voltage	54.4V
Shut Down(cut off) Voltage	49.4V
Shut Down(cut off) SOC	25%
Max Charge Current	50A*battery QTY
Max Discharge Current	50A*battery QTY

12 Trouble Shooting Guideline

Please refer to the table below for detailed information:

Phenomenon	LED Alarm	Cause	Solution
System not working properly	Flashes 1 time every 5 seconds	Battery ID address is duplicated	Check whether the battery ID has duplicate addresses. After modification, please shut down and restart all batteries with duplicate addresses
The system shuts down after running for about 10 minutes	Flashes twice every 5 seconds	Master battery protocol and inverter protocol are not compatible	Check the master battery protocol address, please restart the master after modification
System not working properly	Flashes 3 times every 5 seconds	Hardware Fault	Check whether the battery ID has duplicate addresses. After modification, please shut down and restart all batteries with duplicate addresses
The system shuts down after running for about 10 minutes	Flashes twice every 5 seconds	Master battery protocol and inverter protocol are not compatible	Check the master battery protocol address, please restart the master after modification
The master is running normally, and the battery of the slave is turned off	Flashes 6 times every 5 seconds	No communication between master and slave	Check whether the communication cable between the master and slave is correct, whether the communication interface is plugged in correctly, and whether it is inserted firmly

Phenomenon	LED Alarm	Cause	Solution
System not working properly	Flashes 7 times every 5 seconds	There is a problem with the charging MOSFET	Stop charging and discharging, turn off the battery and contact the after-sales personnel, do not touch the positive and negative poles of the battery, let the professionals finalize it
System not working properly	Flashes 8 times every 5 seconds	There is a problem with the discharging MOSFET	Stop charging and discharging, turn off the battery and contact the after-sales personnel, do not touch the positive and negative poles of the battery, let the professionals finalize it
The battery cannot be charged or discharged	Flashes 9 times every 5 seconds	The battery temperature detection harness is damaged	Please contact the after-sales personnel and let the after-sales personnel handle it
System not working properly	Alarm LED always on and SOC is lower than 25%	The battery triggers the mandatory protection state	<ol style="list-style-type: none"> 1. Power off and restart the battery for charging 2. Contact the after-sales personnel
No output after battery power on		<ol style="list-style-type: none"> 1. The master address is wrong 2. MOSFET open 3. FUSE burnt 	<ol style="list-style-type: none"> 1. Check whether master address is 0 2. Is the positive and negative wiring of the battery correct 3. Check whether there is protection through the monitoring software 4. Measure whether the voltage of the positive and negative poles of the battery is low, lower than 42V 5. Contact the after-sales personnel
The battery cannot be charged or discharged	LED always on	Trigger over temperature/under temperature/temperature difference/alarm and protection	Please contact after-sales personnel

NOTE

Damage to the battery system due to under voltages:

- Charge the over-discharged system within seven days when the temperature is above 25°C
- Charge the over-discharged system within fifteen days when the temperature is below 25°C.
- If the battery system doesn't start at all, please contact SOLUNA local after-sales service within 48 hours. Otherwise, the battery could be permanently damaged.

13 Depth of Discharge (DOD) Setting for Inverter

To ensure optimal performance and smooth operation of the battery, we recommend the following settings for the inverter:

On-Grid DOD: 80%

Off-Grid DOD 70%

In energy storage systems, reducing the depth of discharge (DOD) of lithium batteries is aimed at ****improving system economics, extending battery life, enhancing safety, and optimizing performance****. Below are the specific reasons:

1. Extending Battery Life

- The cycle life of lithium batteries is closely related to the depth of discharge. Deep discharge (e.g., 80%-100% DOD) accelerates battery aging, leading to faster capacity degradation.
- Reducing DOD (e.g., controlling it between 20%-80%) can significantly extend the battery's cycle life, thereby lowering long-term maintenance and replacement costs for the energy storage system.

2. Improving System Economics

- Batteries account for a significant portion of the cost in energy storage systems. Extending battery life means reducing the frequency of battery replacements and lowering the total lifecycle cost.
- Although reducing DOD decreases the available energy per cycle, the overall energy throughput (total charge-discharge capacity) may increase by extending battery life, thereby improving economic efficiency.

3. Enhancing Safety

- Deep discharge increases the risk of over-discharge, causing the battery voltage to drop too low, which may lead to irreversible chemical damage (e.g., dissolution of the copper current collector in the anode).
- Reducing DOD can prevent over-discharge, minimize safety risks such as thermal runaway, and ensure stable operation of the energy storage system.

14 Register on the Website after Installation

After completing the installation of the battery system and confirming that it is operating normally, please log in to the Soluna official website to register your product installation and usage details. This registration is required for the product warranty to take effect. Follow the on-screen instructions on the website to complete the registration process.

<https://soluna.co> → SUPPORT & SERVICE → Warranty registration

15 Contact us

If you have any questions, feedback, or need assistance, please feel free to reach out to us. We are here to help!

Soluna (Shanghai) Co.,Ltd

Add: No.3492 Jinqian Road, Shanghai, China 201406

Tel: +86-21-57475835

Email: sales@solunabattery.com

Web: www.solunabattery.com

Social media: <https://www.linkedin.com/company/solunabattery>